

Product Description

Description:	127.50MHz GXO-3200G/F SM Oscillator
Product family:	GXO-3200
Category:	SM Oscillator
Order code:	MP10406

Features

- ▶ Ceramic package with metal lid
- ▶ Enable / disable tristate function

Additional Information

For further information regarding packaging, construction, material composition, soldering profile and environment, please refer to **GXO-3200 Product Information sheet**

For dimensions, refer to package drawing: **D0357-A**

Electrical Specifications

Parameter	Value	Notes
Nominal frequency:	127.50MHz	
Frequency stability:	±10ppm max	Frequency stability is inclusive of calibration @25°C, operating temperature range, supply voltage change, load change, shock and vibration.
Operating temperature range:	-40 to +85°C	
Storage temperature range:	-55 to +125°C	
Supply voltage (V _{DD}):	+1.8V	±5%
Supply current:	20mA max	
Driving ability:	15pF CMOS	
Logic levels:	'0' level = 10%V _{DD} max '1' level = 90%V _{DD} min	
Start up time:	5ms max	
Waveform symmetry:	45:55%	@ 50% V _{DD}
Rise / fall time:	3ns max	10 ~ 90%V _{DD}
Stand-by current:	10µA max	
Phase jitter RMS:	0.3ps typ	12kHz ~ 20.0MHz

Enable / Disable Function

Input (pad 1)	Output (pad 3)
Open	Enabled
'1' level	Enabled
'0' level	High Impedance

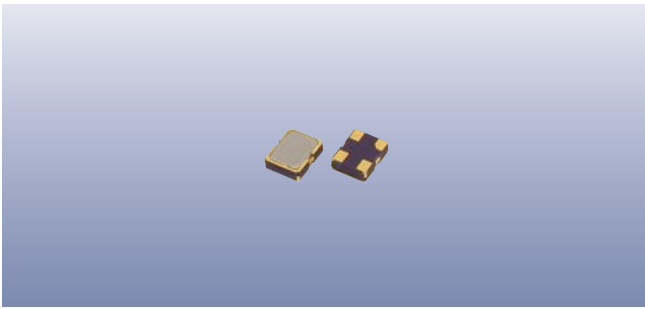

Construction

- ▮ Ceramic body with gold-plated pads
- ▮ Metal lid, seam sealed

Composition



This product is lead-free, and is fully compliant with current RoHS directives



Packaging & Handling

Production quantities supplied on T&R, 3k pcs per reel.
Small quantities may be supplied on tape (no reel), or in bulk.



♦ Static sensitive product. Observe proper handling precautions

Marking

FREQUENCY
K DC

Marking type: Laser
DC = Date code in YM, eg "GE" = May 2017

	A	B	C	D	E	F	G	H	J	K	L	M
Y	1	2	3	4	5	6	7	8	9	0		
M	Jan	Feb	Mar	Apr	May	Jun	Jul	Aug	Sep	Oct	Nov	Dec

Tape & Reel Specification

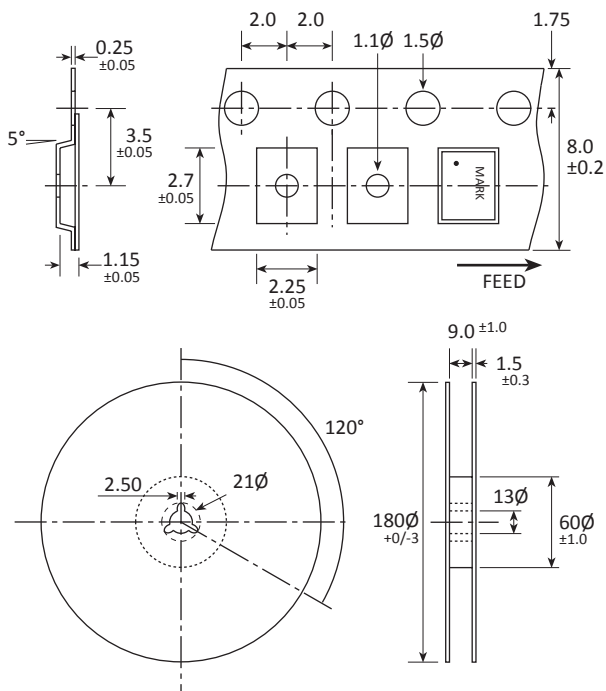

Not to scale. Dimensions in mm. Tolerances ±0.1mm unless otherwise stated.

Soldering Profile

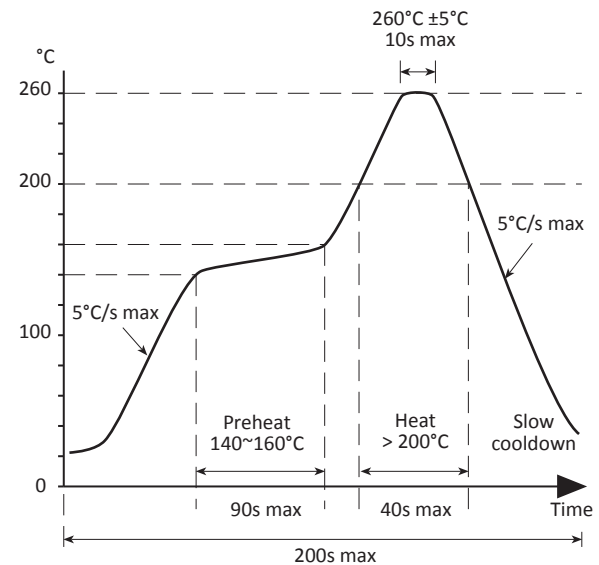

Solder resistance: 260°C x 10 secs x 2.

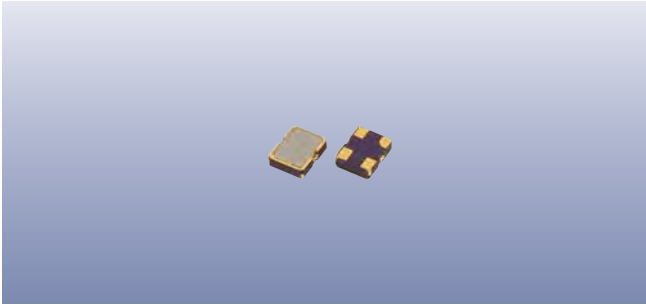

Product Family

GXO-U120, GXO-3200

Construction

- ▮▮▮▮ Ceramic body with gold-plated pads
- ▮▮▮▮ Metal lid, seam sealed

Dimensions (mm)

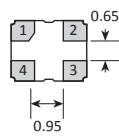
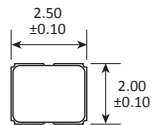

SOLDER PAD LAYOUT

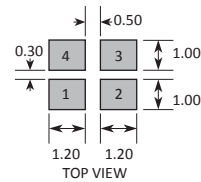

PAD	CONNECTION
1	Enable/Disable
2	Ground
3	Output
4	Supply