

SAW Filter 70.0MHz
Part No: MP10800

Model: TB0202B
Rev. No: 1

A. MAXIMUM RATING:

Electrostatic Sensitive Device

1. Input Power Level: 10dBm
2. Operating Temperature: -40°C to +85°C
3. Storage Temperature: -40°C to +85°C
4. Moisture Sensitivity Level: Level1 (MSL1)

B. ELECTRICAL CHARACTERISTICS:

Ambient Temperature: 25°C

Item	Unit	Min.	Typ.	Max.	Note
Center frequency Fc	MHz	-	70	-	
Insertion Loss IL	dB	-	14.5	16.5	
1dB Bandwidth	MHz	18.7	19.48	-	
3dB Bandwidth	dB	-	20.3	-	
40dB Bandwidth	MHz		20.8	25	
Passband ripple Fc ±8.2MHz	dB	-	0.45	1.0	
Group Delay ripple Fc ±8.2MHz	nS		25	60	
Absolute Delay	µS	-	0.9	-	
Attenuation Reference level from Min IL)					
35MHz ~ 57.75MHz	dB	40	45	-	
82.75MHz ~105MHz	dB	40	45	-	
Temperature Coefficient	ppm/°C	-	-86	-	

C. MEASUREMENT CIRCUIT:

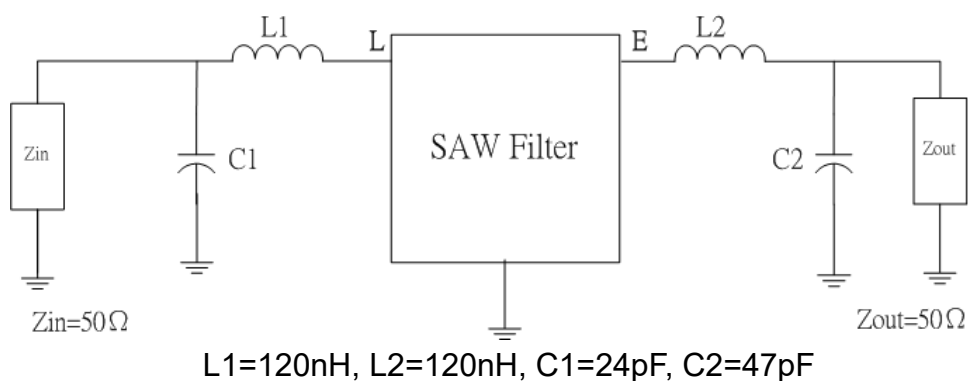

SAW Filter 70.0MHz
Part No: MP10800

Model: TB0202B
Rev. No: 1

D. FREQUENCY CHARACTERISTICS:

Bandwidth at -1.0 dB

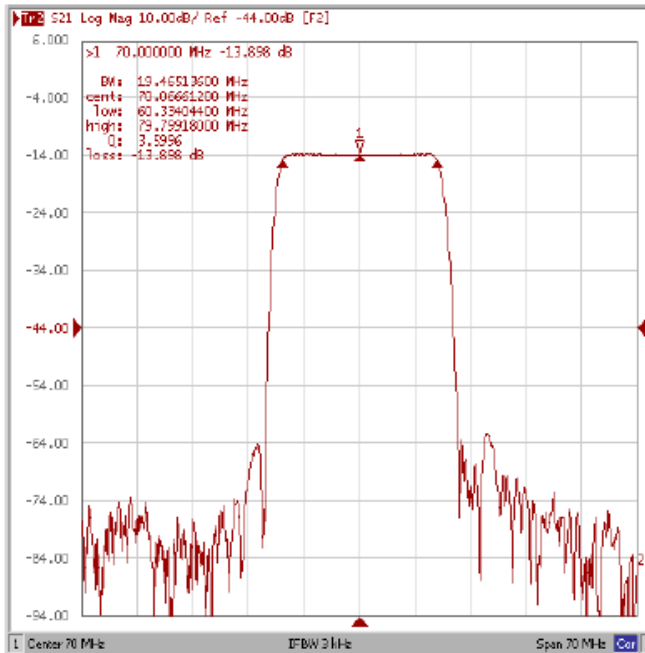

Bandwidth at -3.0 dB

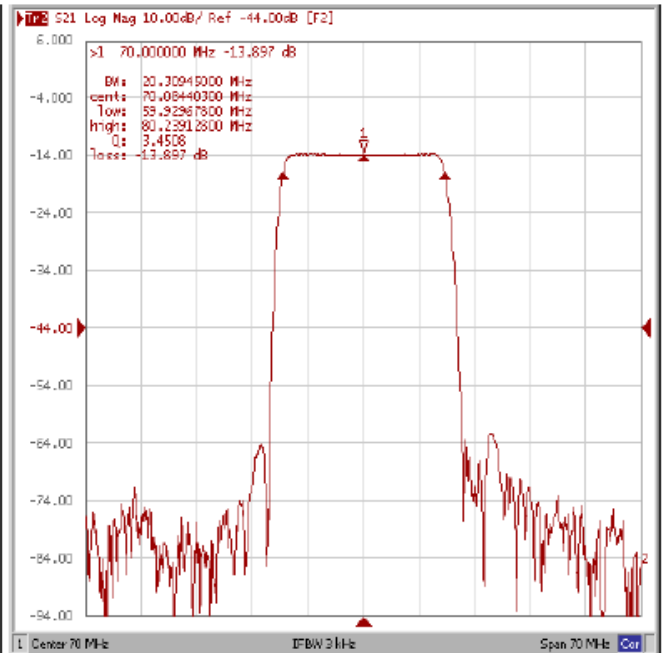

Bandwidth at -40 dB

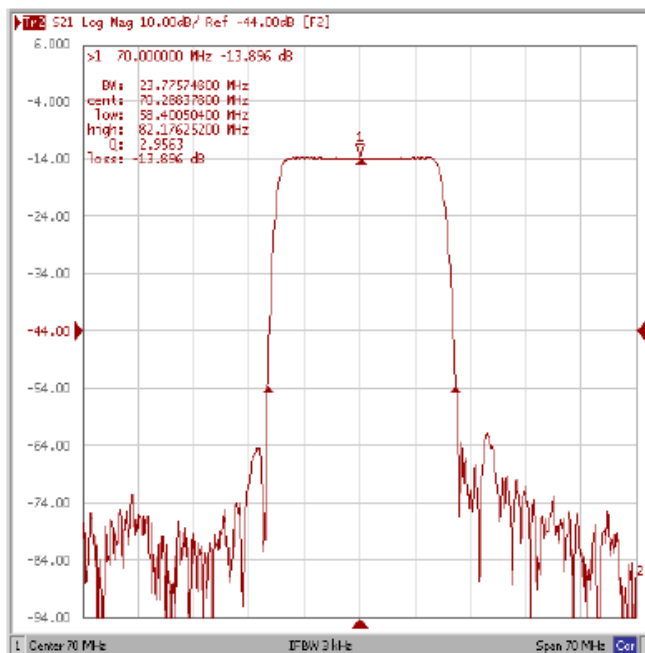

Relative Attenuation

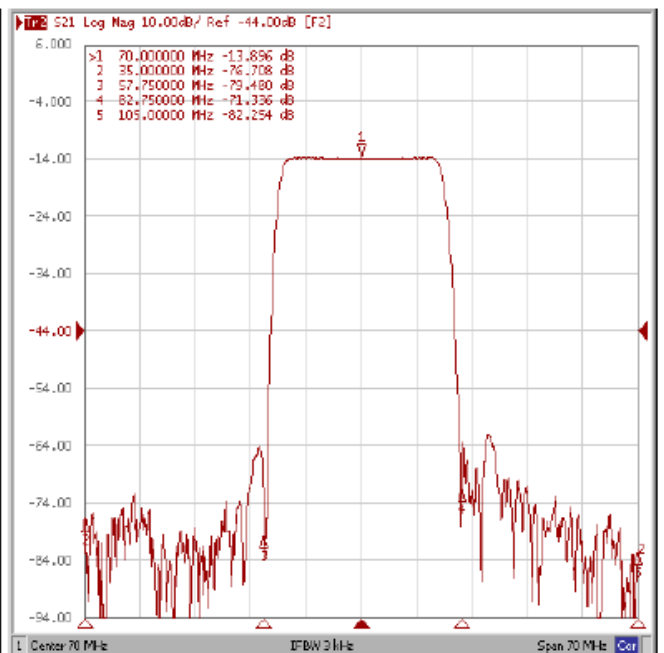

SAW Filter 70.0MHz
Part No: MP10800

Model: TB0202B
Rev. No: 1

Ripple Variation Fo \pm 8.2MHz

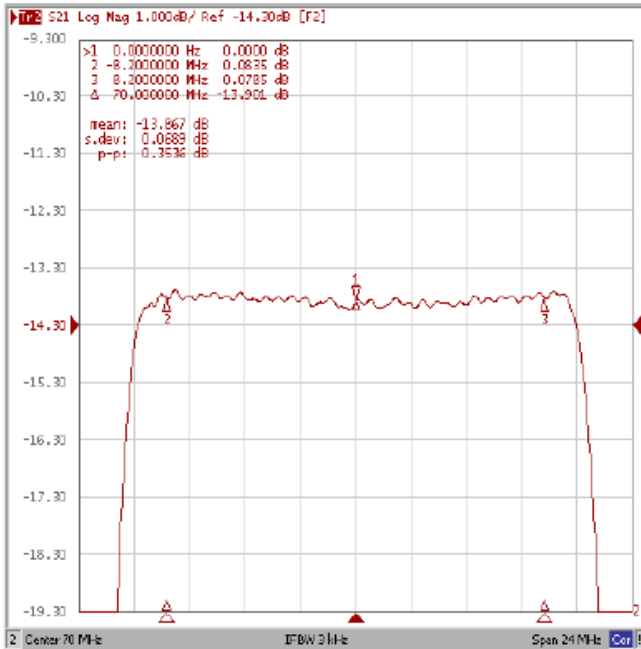

Group Delay Variation Fo \pm 8.2MHz

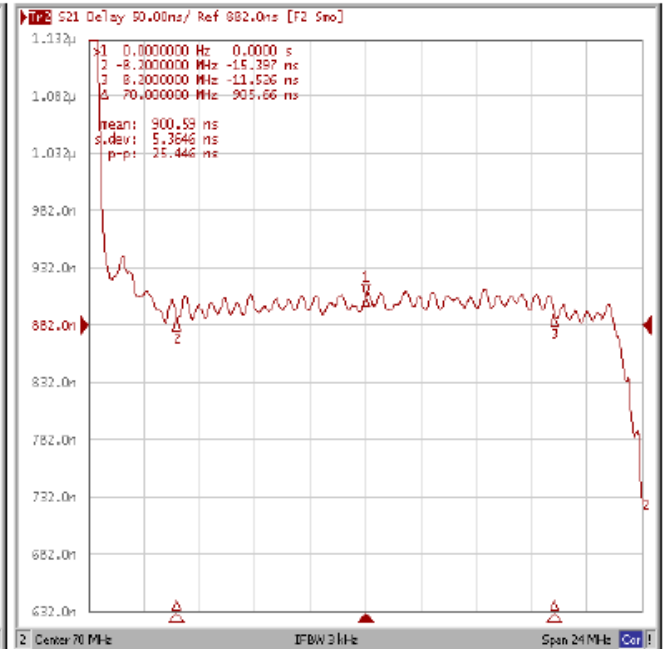

Smith Chart

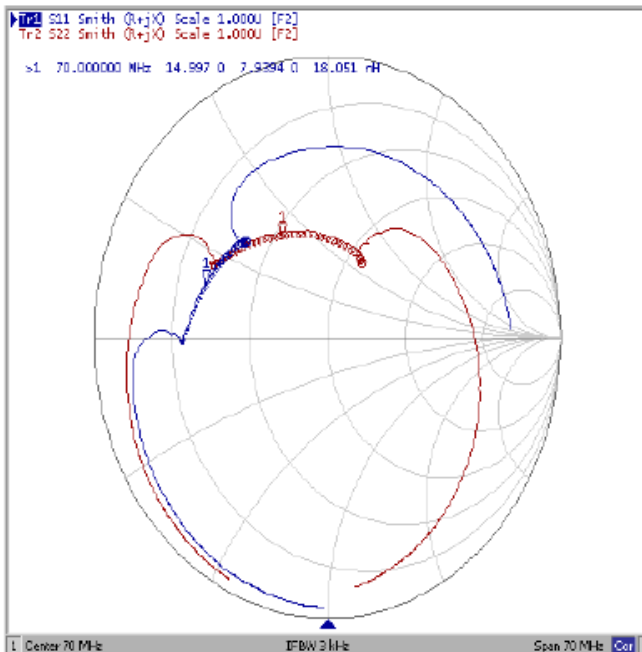

VSWR

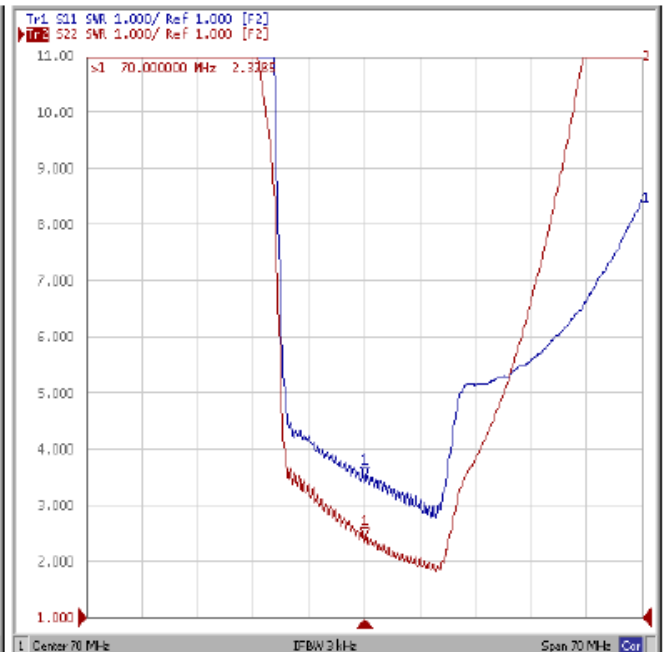

SAW Filter 70.0MHz
Part No: MP10800

Model: TB0202B
Rev. No: 1

H. RECOMMENDED REFLOW PROFILE:

1. Preheating shall be fixed at 150~180°C for 60~90 seconds.
2. Ascending time to preheating temperature 150°C shall be 30 seconds min.
3. Heating shall be fixed at 220°C for 50~80 seconds and at 260°C +0/-5°C peak (20 ~ 40 sec).
4. Time: 2 times.

