

SAW Filter 925.20MHz
Part No: MP06996

Model: TA1720A
Rev No: 2

A. MAXIMUM RATING:

Electrostatic Sensitive Device (ESD)

1. Input Power Level: 13dBm
2. DC Voltage: 6V
3. Operating Temperature: -30°C to +85°C
4. Storage Temperature: -40°C to +85°C

B. ELECTRICAL CHARACTERISTICS:

1. Terminating source impedance (single): $Z_S = 50\Omega$
2. Terminating load impedance (single): $Z_L = 50\Omega$

Item	Unit	Min	Typ.	Max
Center Frequency Fc	MHz	-	925.2	-
Insertion Loss (922.3 ~ 928.1MHz) IL	dB		2.5	3.5max
Amplitude ripple (922.3 ~ 928.1MHz)	dB		0.6	1.5max
VSWR Input (922.3 ~ 928.1MHz)			1.4	2.0
VSWR Output (922.3 ~ 928.1MHz)			1.4	2.0
Attenuation				
10 ~ 815MHz	dB	42	45	
815 ~ 875MHz	dB	40	45	
875 ~ 905MHz	dB	35	40	
905 ~ 915MHz	dB	11	15	
945 ~ 950MHz	dB	35	40	
950 ~ 1150MHz	dB	50	55	
1150 ~ 1856MHz	dB	32	35	
1856 ~ 2500MHz	dB	32	35	
Package size	mm	SMD 3x3		

C. TEST CIRCUIT:

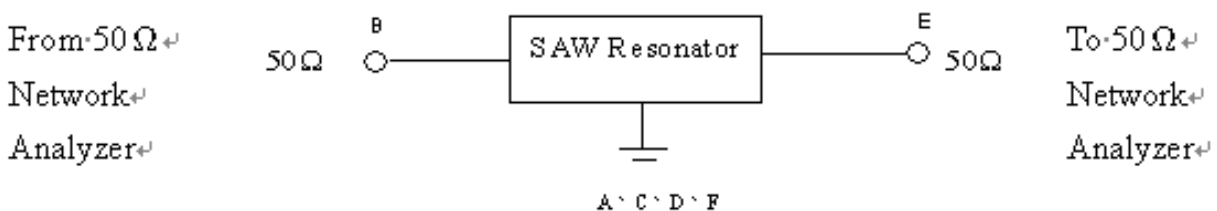

SAW Filter 925.20MHz
Part No: MP06996

Model: TA1720A
Rev No: 2

D. FREQUENCY CHARACTERISTICS:

1. S21 response: 200MHz

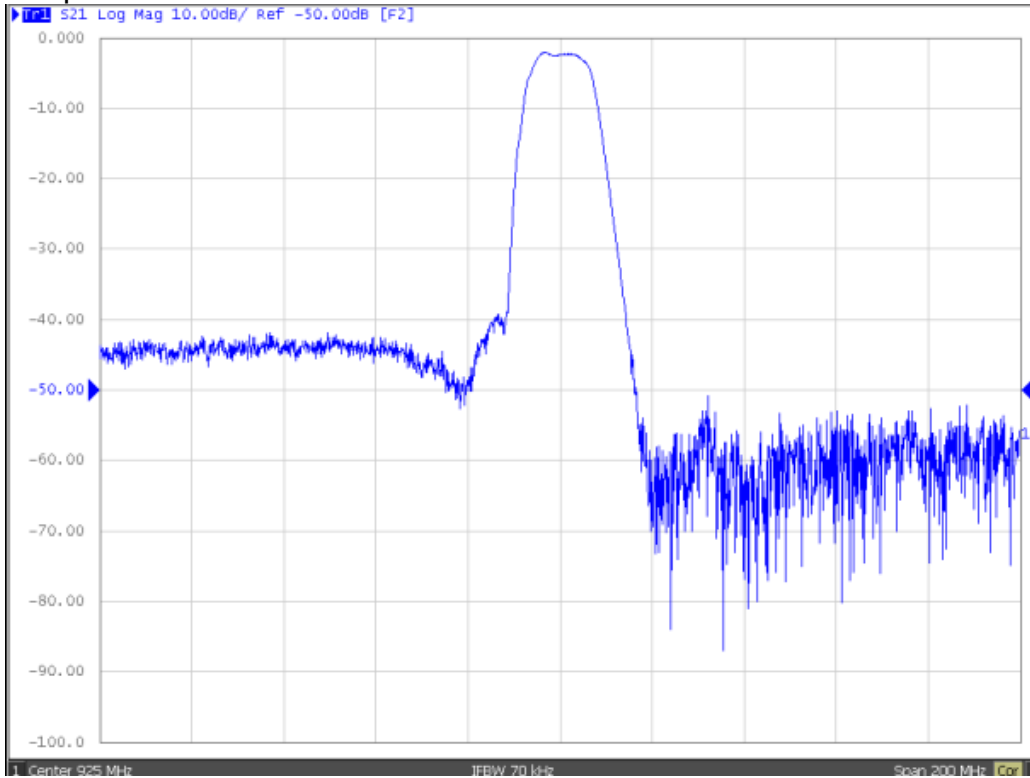

2. S21 response: 20MHz

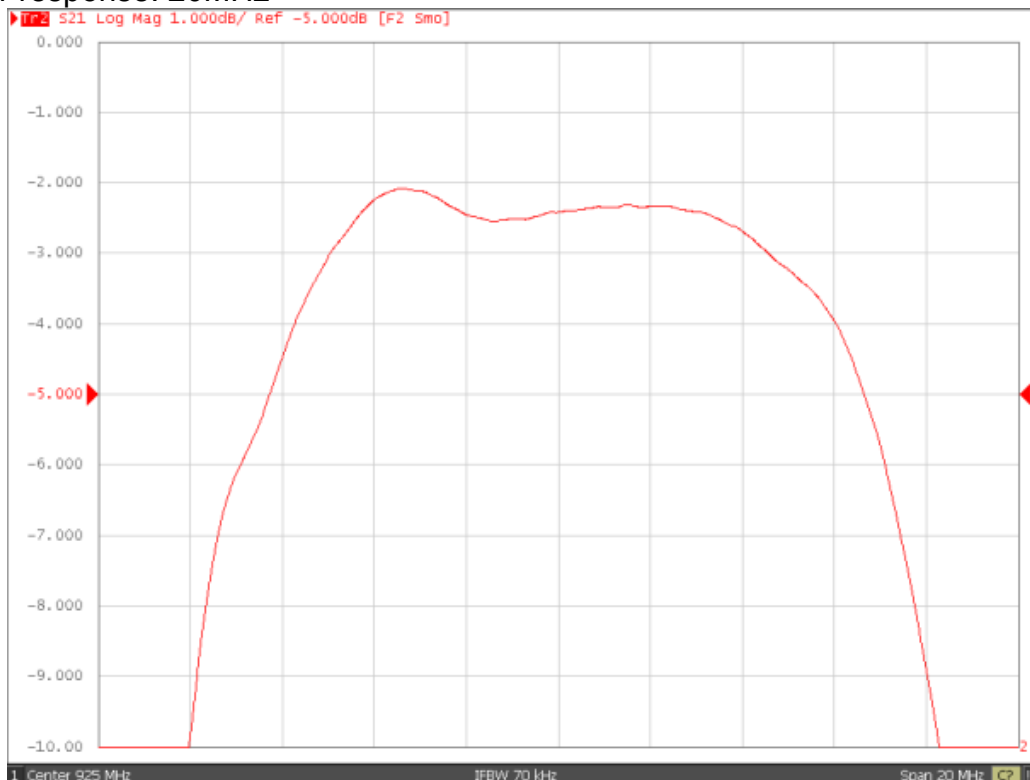

SAW Filter 925.20MHz
Part No: MP06996

Model: TA1720A
Rev No: 2

3. S21 response: 1 ~ 3000MHz

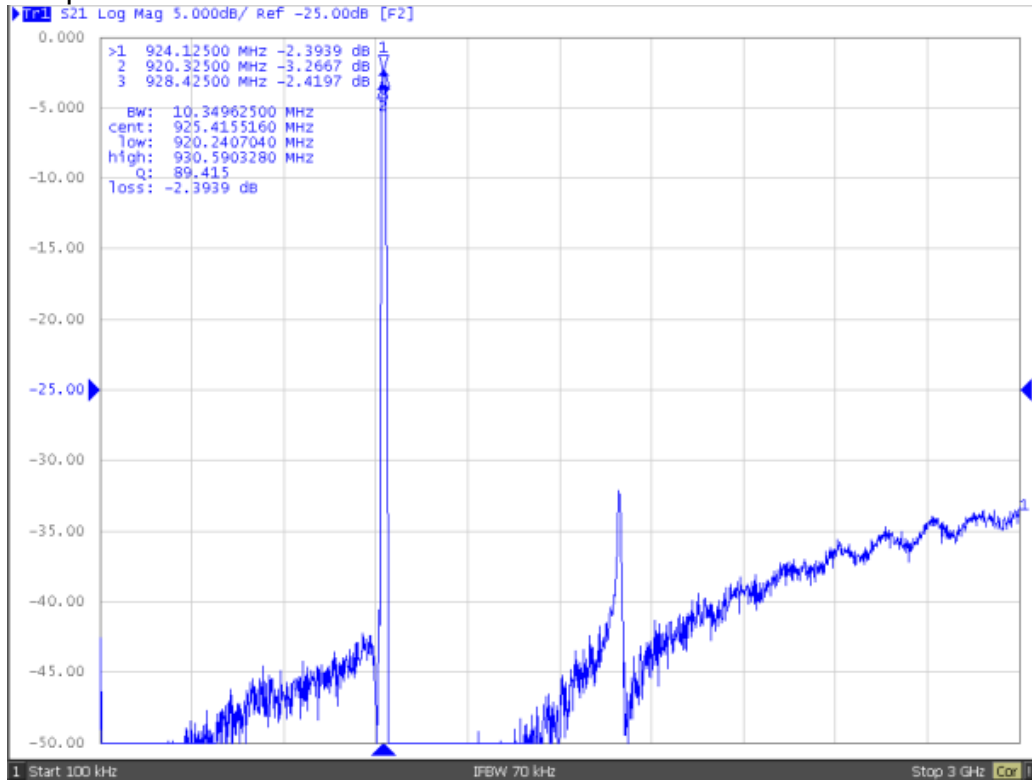

SAW Filter 925.20MHz
Part No: MP06996

Model: TA1720A
Rev No: 2

4. S11/S22 response:

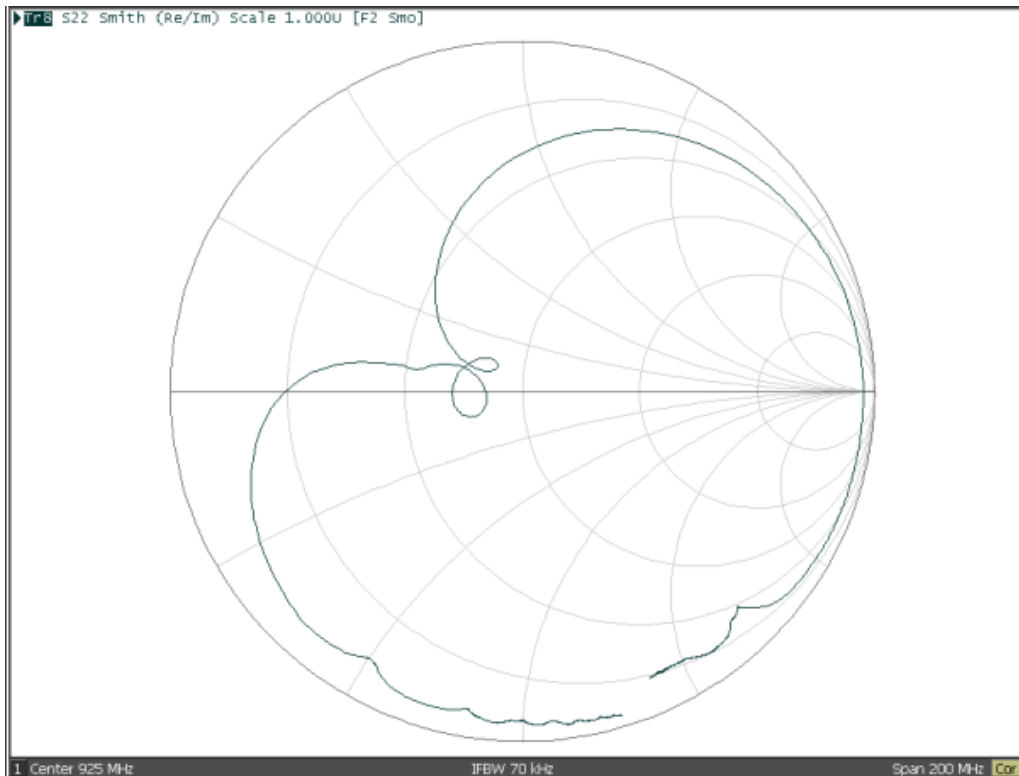
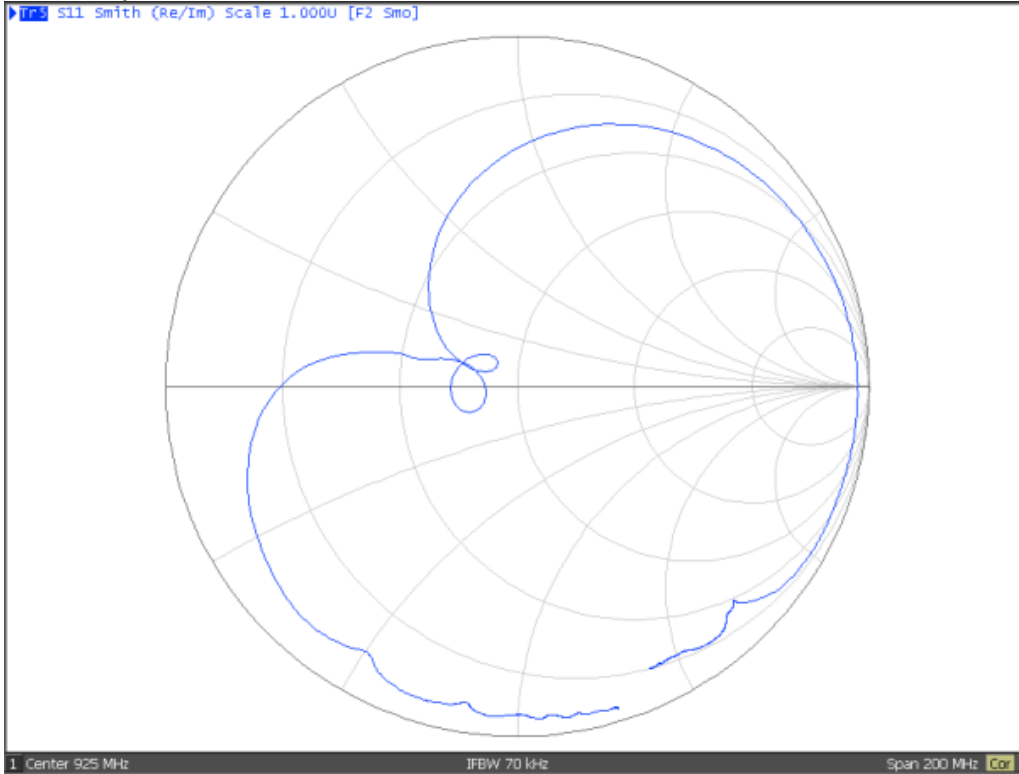

SAW Filter 925.20MHz
Part No: MP06996

Model: TA1720A
Rev No: 2

E. OUTLINE DRAWING:

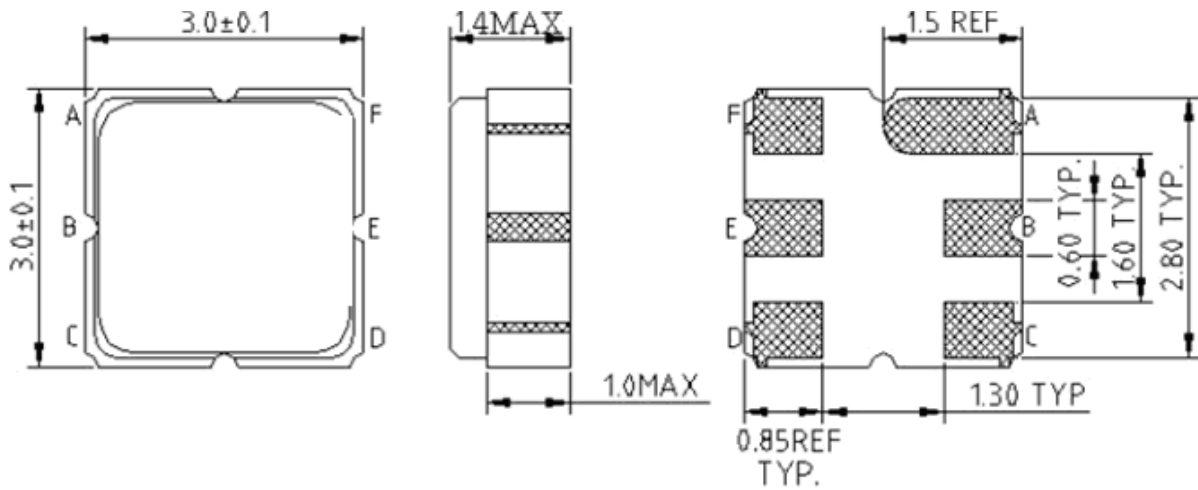

#B: Input
#E: Output
A.C.D.F Ground

Unit: mm

SAW Filter 925.20MHz
Part No: MP06996

Model: TA1720A
Rev No: 2

F. PACKING:

1. Reel Dimension (Please refer to FR-75D10 for packing quantity)

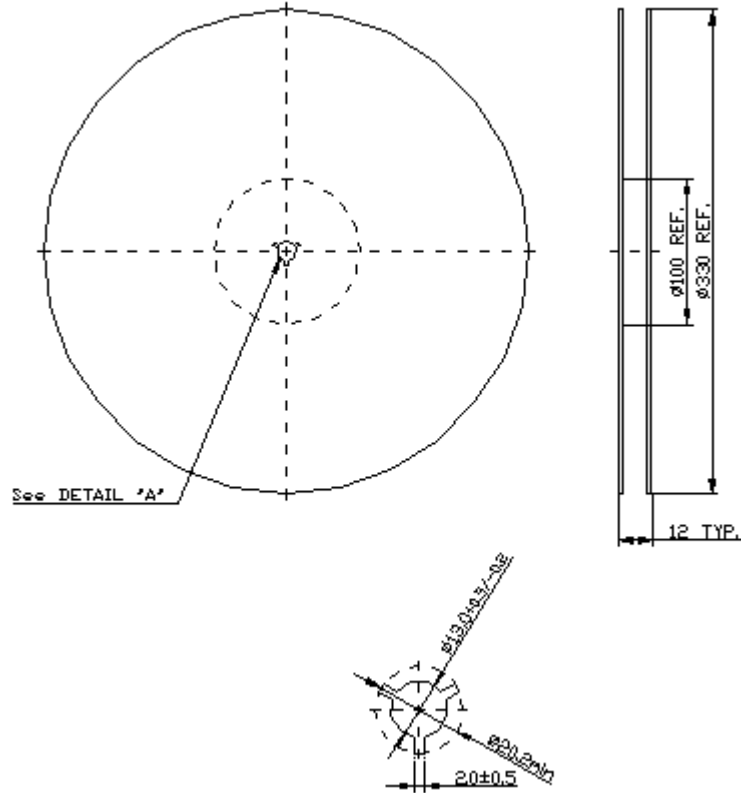

2. Tape Dimension

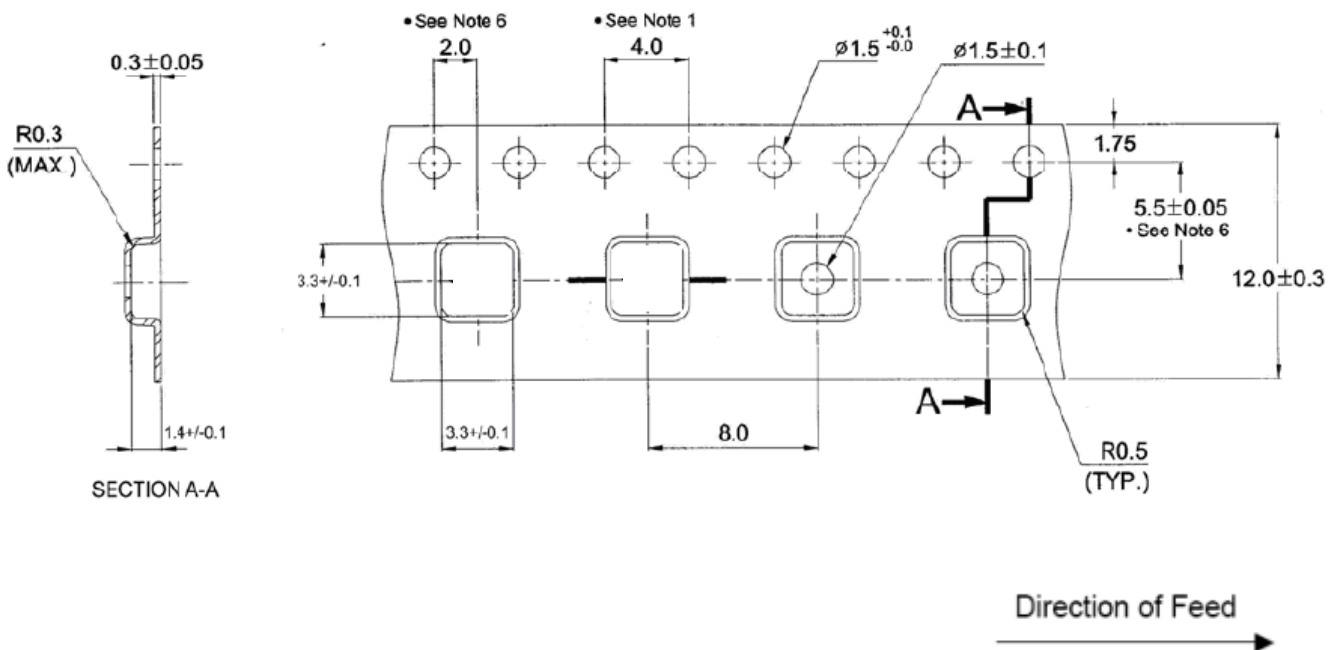

SAW Filter 925.20MHz
Part No: MP06996

Model: TA1720A
Rev No: 2

G. RECOMMENDED REFLOW PROFILE:

1. Preheating shall be fixed at 150 ~ 180°C for 60 ~ 90 seconds.
2. Ascending time to preheating temperature 150°C shall be 30 seconds min.
3. Heating shall be fixed at 220°C for 50 ~ 80 seconds and at 260°C +0/-5°C peak (20 ~ 40sec).
4. Time: 2 times.

