

SAW Filter: 352.0MHz
Part No: MP05441

Model: TA1528A
Rev No: 2

A. MAXIMUM RATING:

Electrostatic Sensitive Device (ESD)

1. Input Power Level: 10dBm
2. DC Voltage: 3V
3. Operating Temperature: -40°C to +85°C
4. Storage Temperature: -40°C to +85°C

B. ELECTRICAL CHARACTERISTICS:

Item	Unit	Min.	Typ.	Max.
Center frequency Fc	MHz	-	352	-
Insertion Loss (351.5 ~ 352.5MHz) IL	dB	-	1.9	3.6
Amplitude Ripple (351.5 ~ 352.5MHz)	dB	-	0.2	2.1
VSWR (351.5 ~ 352.5MHz)	-	-	1.4	2.1
Attenuation (Reference level from 0dB)				
10 ~ 296MHz	dB	40	46	-
296 ~ 305MHz	dB	40	45	-
305 ~ 340MHz	dB	10	42	-
393 ~ 600MHz	dB	33	38	-
Temperature coefficient of frequency	ppm/k	-	-36	-

C. MEASUREMENT CIRCUIT:

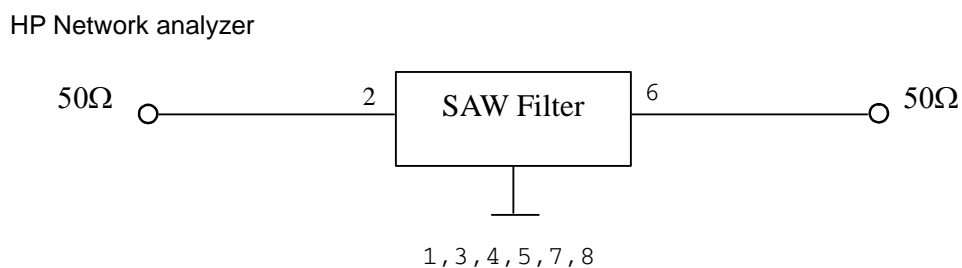

SAW Filter: 352.0MHz
Part No: MP05441

Model: TA1528A
Rev No: 2

D. OUTLINE DRAWING:

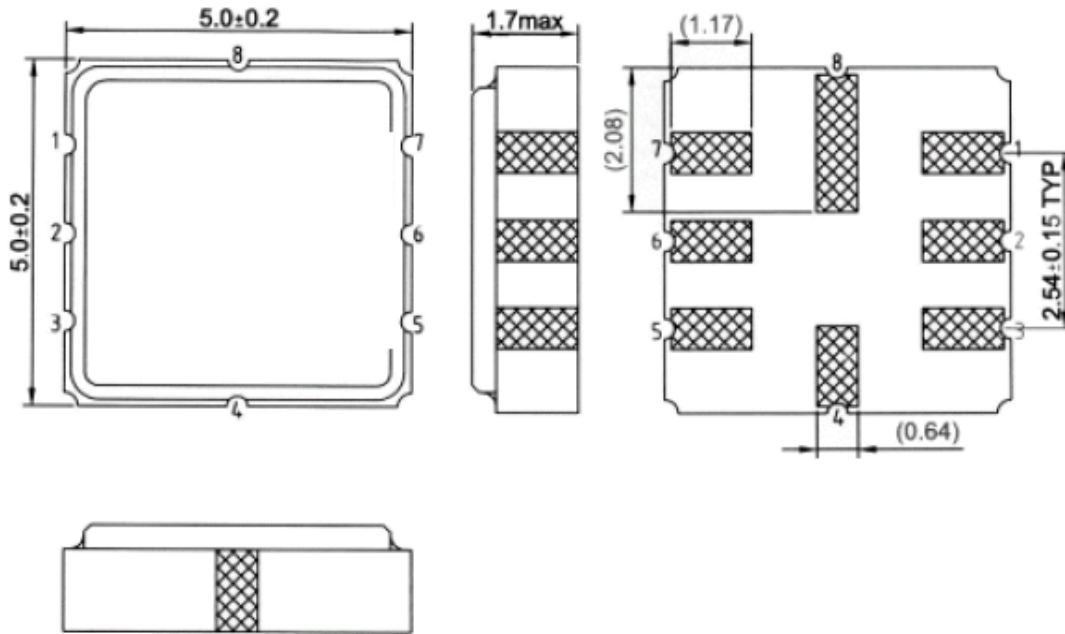

- 2: Input
- 6: Output
- 4, 8: Case Ground
- 1, 3, 5, 7: Ground

E. PCB FOOTPRINT:

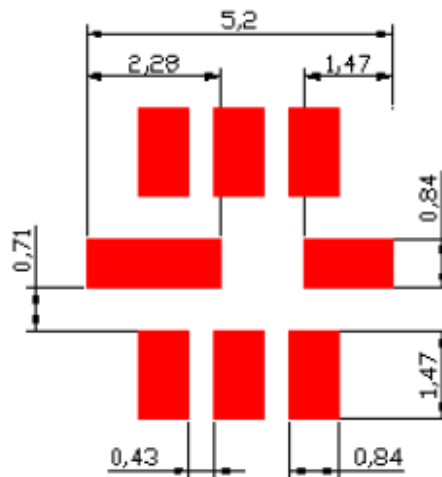

SAW Filter: 352.0MHz
Part No: MP05441

Model: TA1528A
Rev No: 2

F. FREQUENCY CHARACTERISTICS:

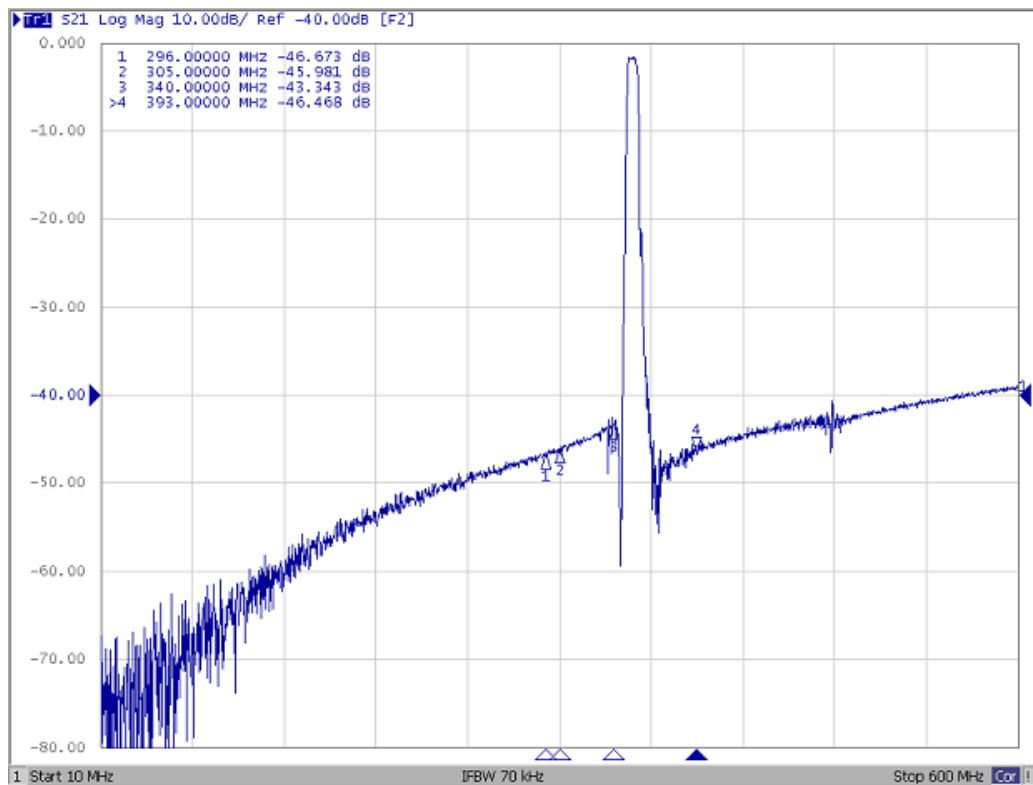

SAW Filter: 352.0MHz
Part No: MP05441

Model: TA1528A
Rev No: 2

Reflection Functions

S11

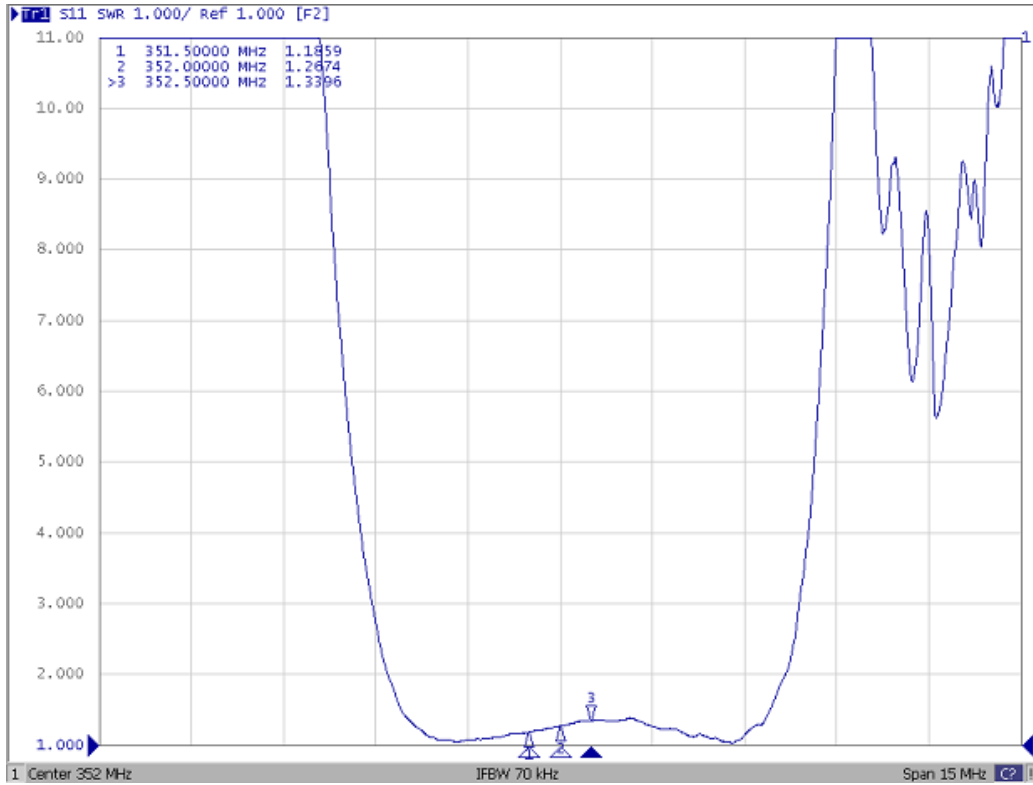

S22

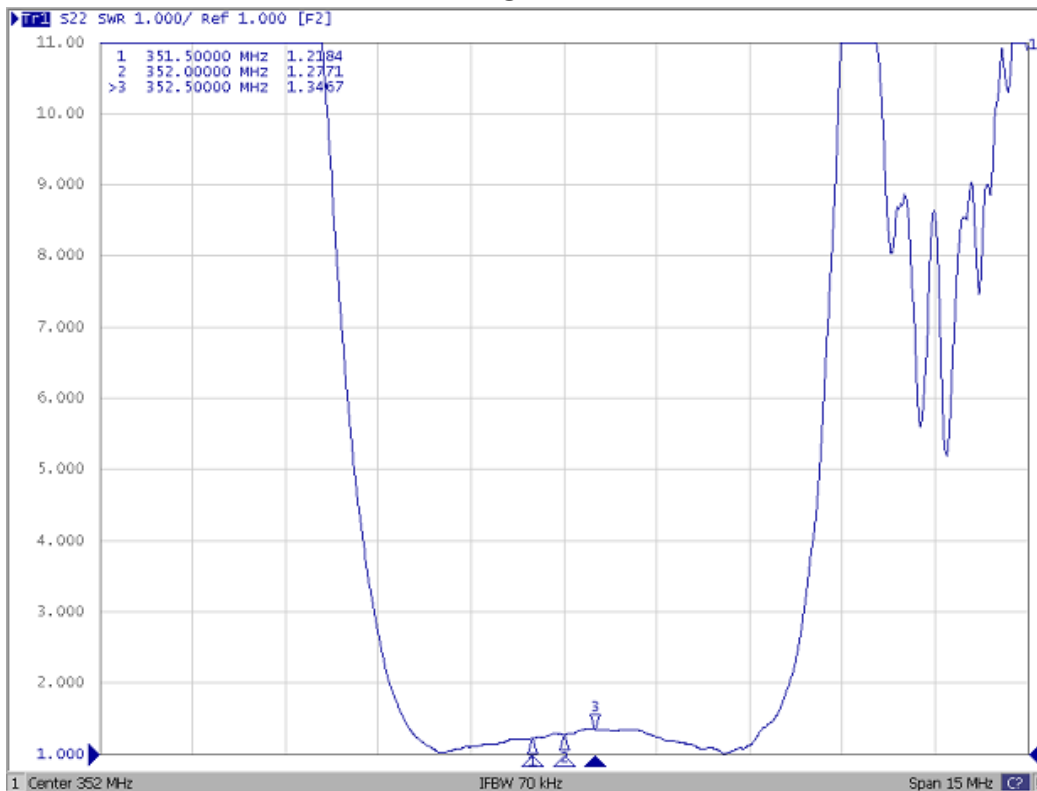

SAW Filter: 352.0MHz
Part No: MP05441

Model: TA1528A
Rev No: 2

G. PACKING:

1. Reel Dimension

(Reel Count: 7" = 1000; 13"=3000)

(Please refer to FR-75D10 for packing quantity)

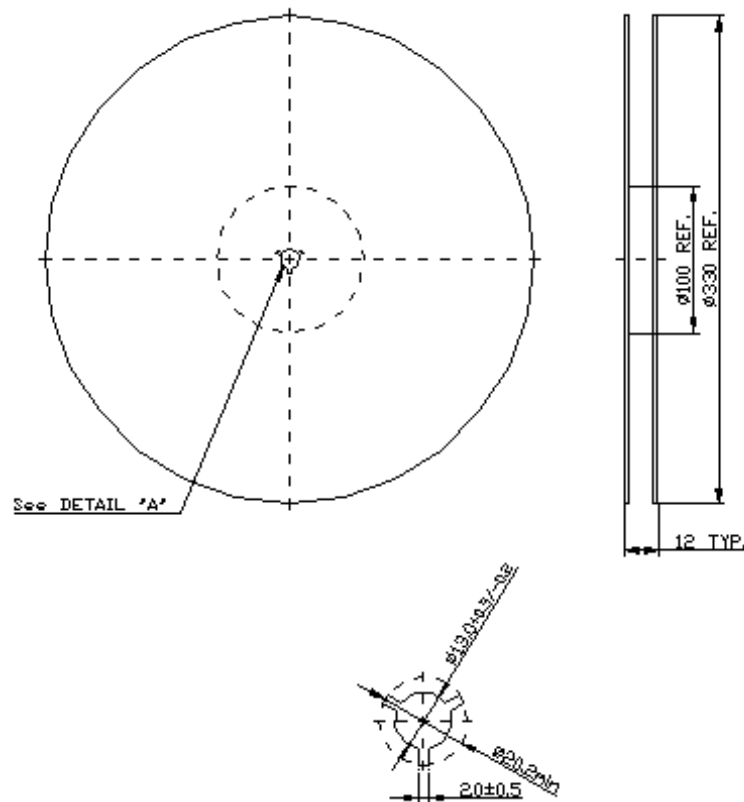

2. Tape Dimension

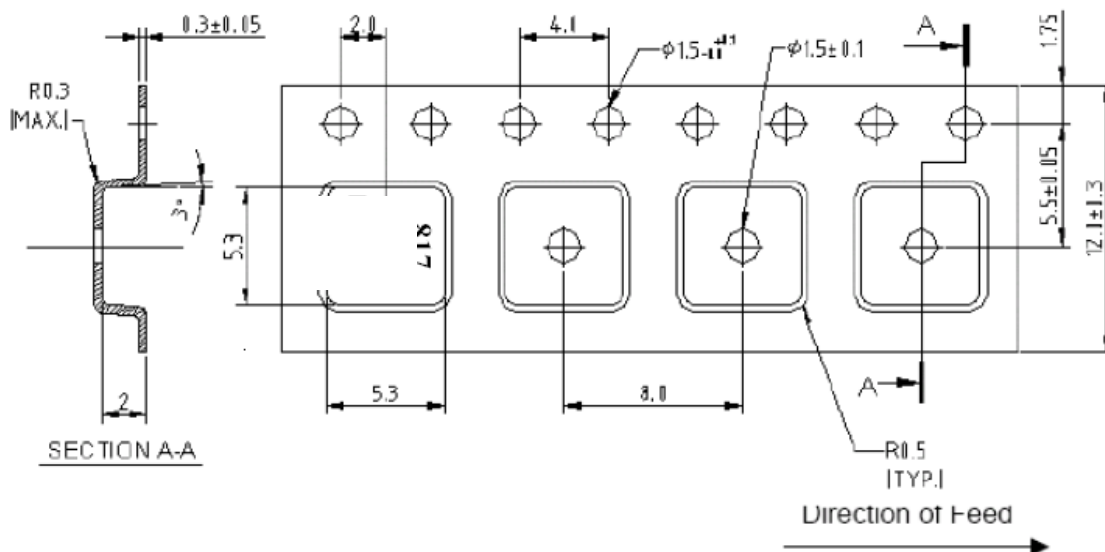

SAW Filter: 352.0MHz
Part No: MP05441

Model: TA1528A
Rev No: 2

H. RECOMMENDED REFLOW PROFILE:

