

SAW Filter 345.0MHz

Model: TA1418A

Part No: MP04683

Rev No: 1

A. MAXIMUM RATING:

Electrostatic Sensitive Device (ESD)

1. Input Power Level: 10dBm
2. DC Voltage: 3V
3. Operating Temperature: -25°C to +85°C
4. Storage Temperature: -40°C to +85°C

B. ELECTRICAL CHARACTERISTICS:

Item	Unit	Min.	Typ.	Max.
Center frequency Fc	MHz	-	345	-
Insertion Loss (344.6 ~ 345.4MHz) IL	dB	-	2.3	3.3
Amplitude ripple (344.6 ~ 345.4MHz)	dB	-	0.4	1.3
Attenuation (Reference level from 0)				
10 ~ 320MHz	dB	50	60	-
320 ~ 325MHz	dB	50	55	
325 ~ 333.5MHz	dB	35	40	
333.5 ~ 335MHz	dB	50	55	
335 ~ 337MHz	dB	40	45	
354 ~ 362MHz	dB	25	30	-
362 ~ 370MHz	dB	38	42	-
370 ~ 700MHz	dB	50	55	-
700 ~ 1000MHz	dB	32	42	-
Temperature Coefficient of Frequency	ppm/°C	-	-30	-

C. MEASUREMENT CIRCUIT:

HP Network analyzer

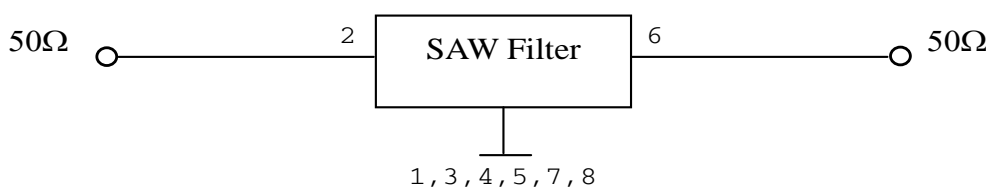

SAW Filter 345.0MHz
Part No: MP04683

Model: TA1418A
Rev No: 1

D. OUTLINE DRAWING:

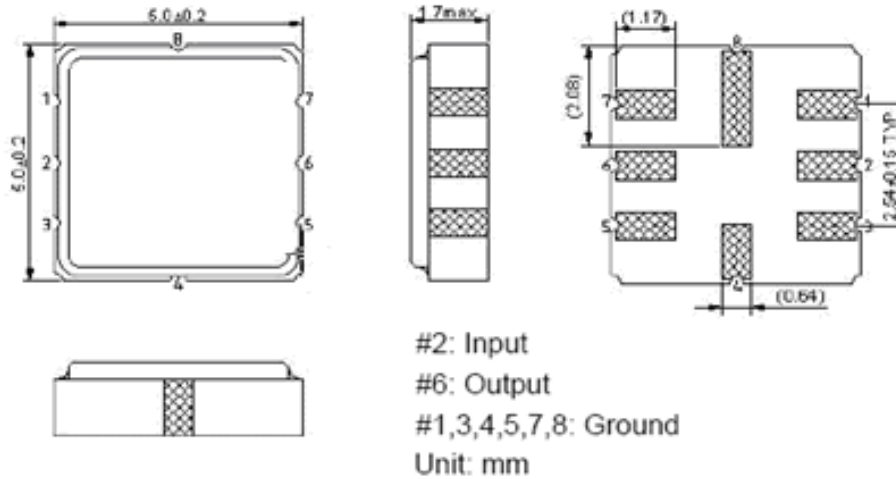

E. PCB FOOTPRINT:

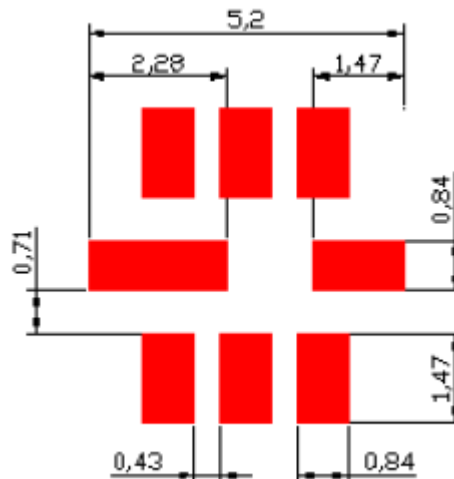

SAW Filter 345.0MHz
Part No: MP04683

Model: TA1418A
Rev No: 1

F. FREQUENCY CHARACTERISTICS:

1. S21 Measurement

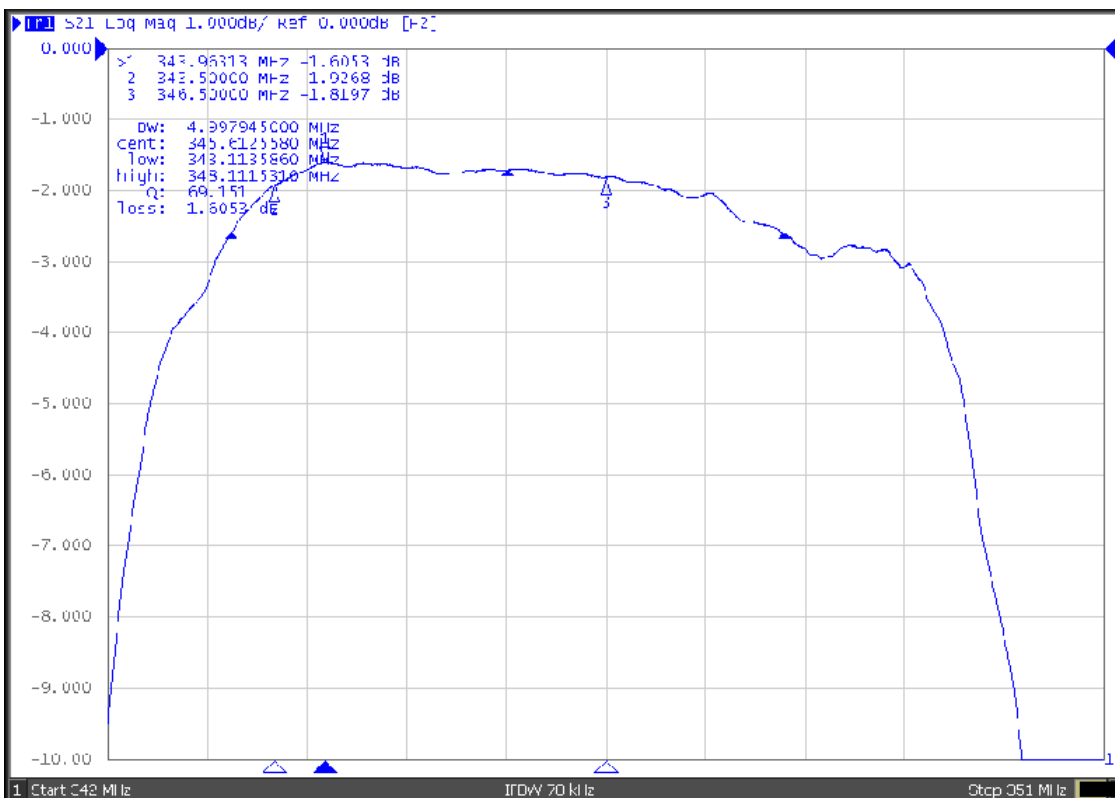
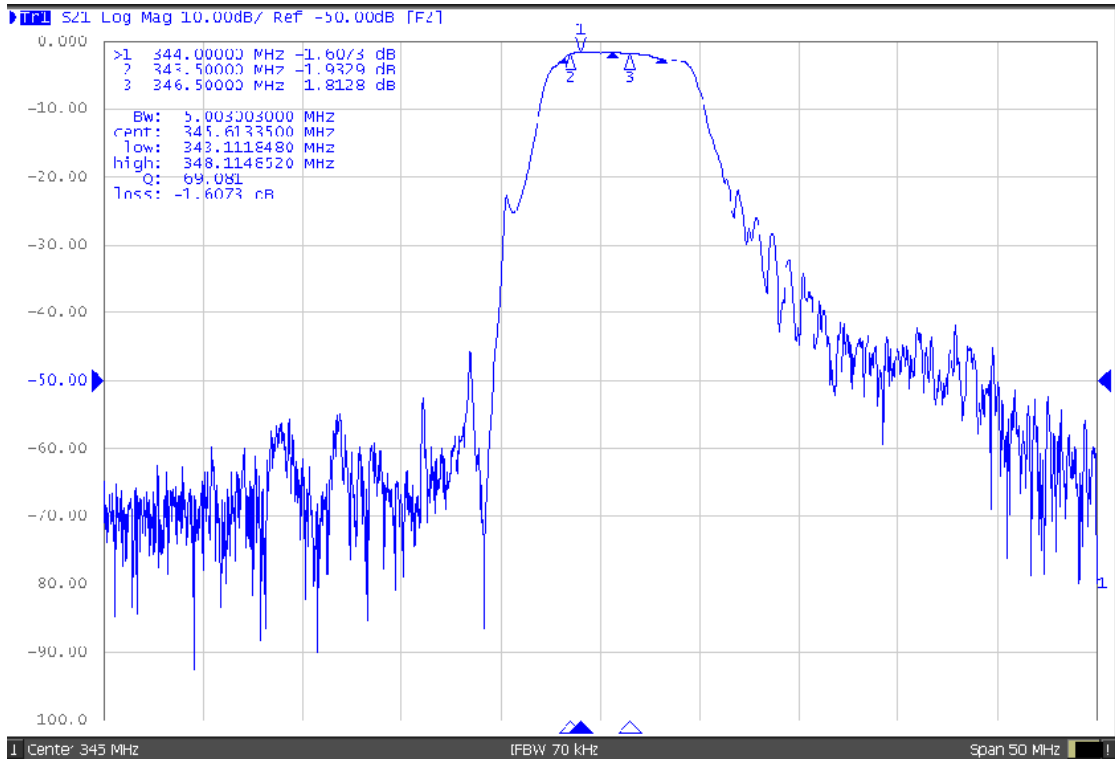

SAW Filter 345.0MHz
Part No: MP04683

Model: TA1418A
Rev No: 1

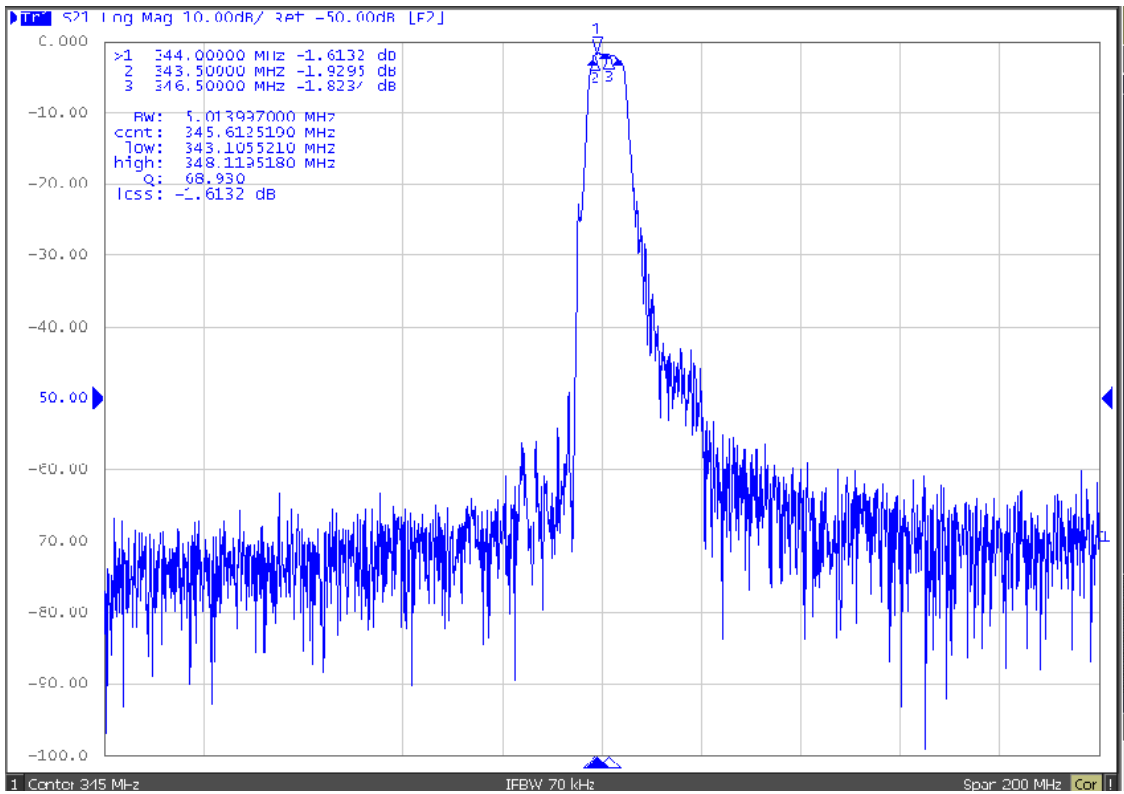

SAW Filter 345.0MHz
Part No: MP04683

Model: TA1418A
Rev No: 1

2. S11 / S22 Measurement

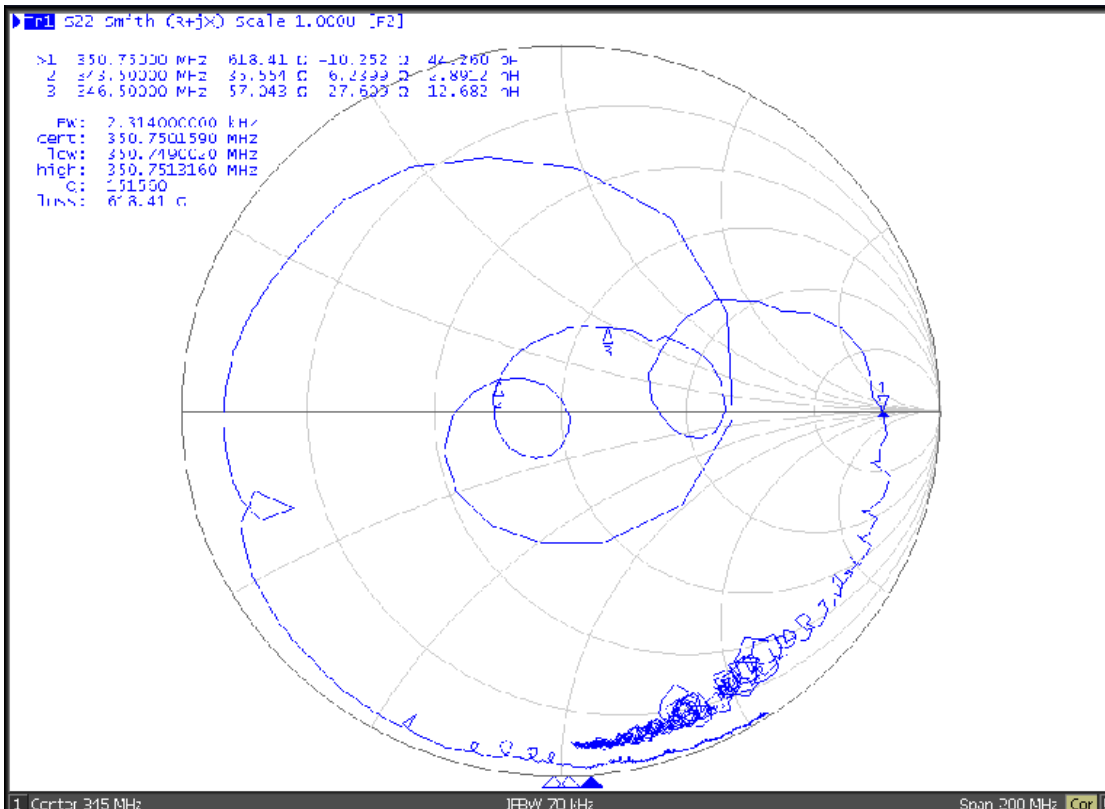
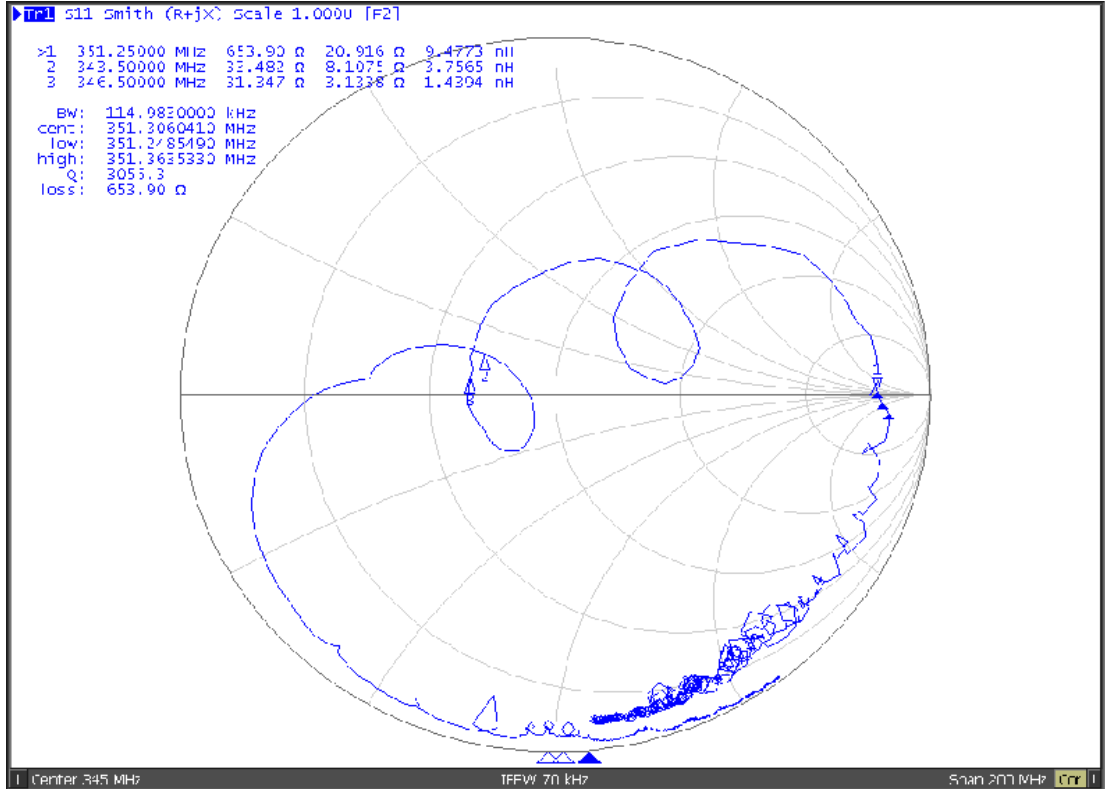

SAW Filter 345.0MHz
Part No: MP04683

Model: TA1418A
Rev No: 1

G. PACKING:

1. Reel Dimension

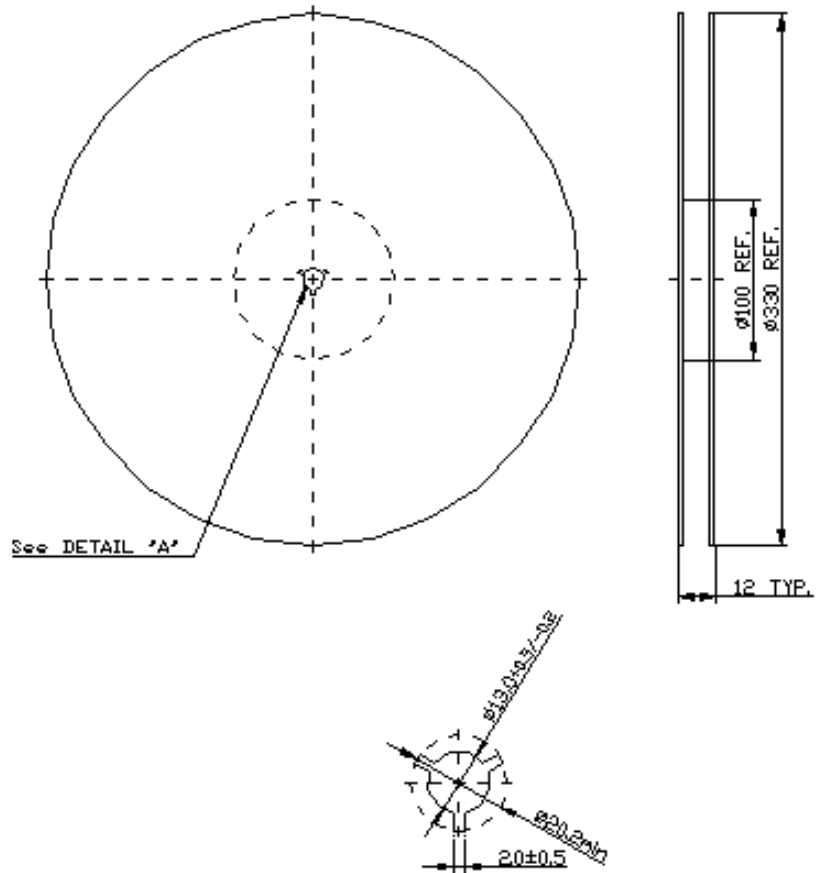

2. Tape Dimension

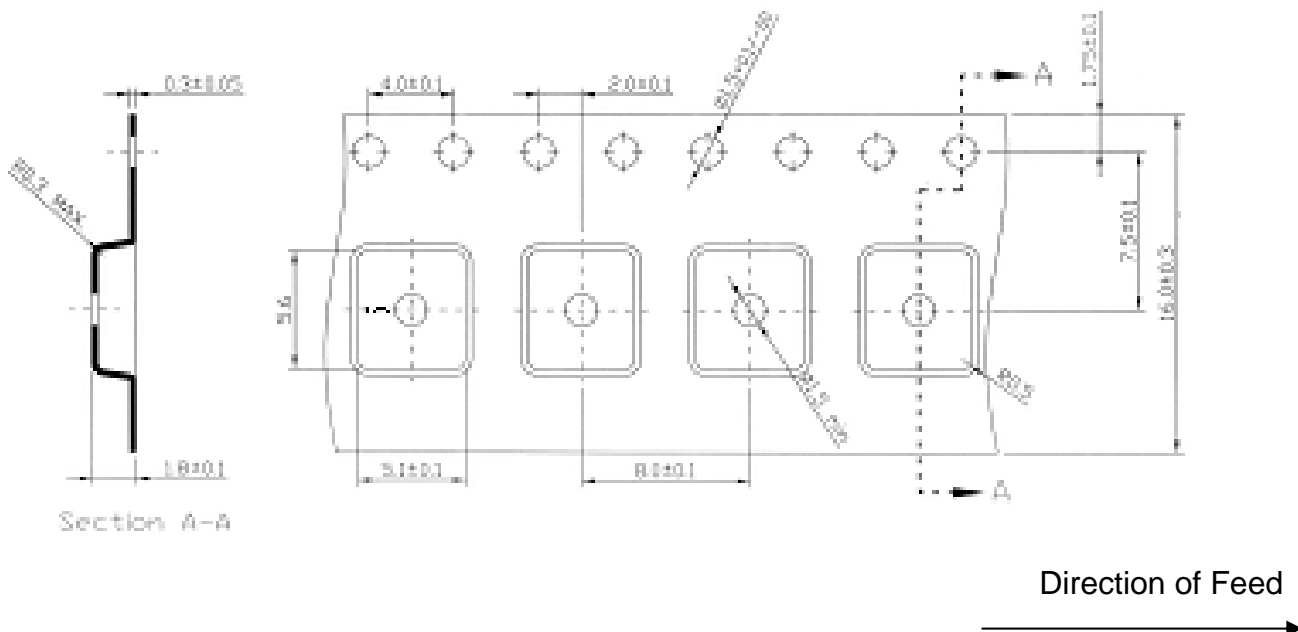

SAW Filter 345.0MHz
Part No: MP04683

Model: TA1418A
Rev No: 1

H. RECOMMENDED REFLOW PROFILE:

