

**SAW Filter 2375MHz**  
**Part No: MP03154**

**Model: TA1073A**  
**Rev No: 2**

**A. MAXIMUM RATING:**

1. Input Power Level: 10 dBm
2. DC voltage: 3 V
3. Operating Temperature: 0°C to +80°C
4. Storage Temperature: -40°C to +85°C

**B. ELECTRICAL CHARACTERISTICS:**

Item		Min.	Typ.	Max.	
Center frequency	Fc	MHz	-	2375	-
Insertion loss(2360 ~ 2390MHz)	IL	dB	-	1.8	2.5
Insertion loss(2310 ~ 2360MHz)	IL	dB	-	2.8	4.5
Insertion loss(2300 ~ 2310MHz)	IL	dB	-	4.8	6.0
Insertion loss(2390 ~ 2400MHz)	IL	dB	-	2.8	4.5
Amplitude ripple (2360~2390 MHz)		dB	-	0.6	1.0
Amplitude ripple (2310~2360 MHz)		dB	-	1.1	1.5
Amplitude ripple (2300~2310 MHz)		dB	-	1.7	2.5
Amplitude ripple (2390~2400 MHz)		dB	-	1.1	2.0
VSWR (2300~2400 MHz)			1.85	2.5	
Attenuation (Reference level from 0 dB)					
D.C. ~ 2200 MHz		dB	23	29.5	-
2452 ~ 2472 MHz		dB	45	62	-
2472 ~ 4000 MHz		dB	30	35	-
Temperature Coefficient		ppm/°C	-	-36	-
Source impedance	Zs	Ω	-	50	-
Load impedance	ZL	Ω	-	50	-

**SAW Filter 2375MHz**  
**Part No: MP03154**

**Model: TA1073A**  
**Rev No: 2**

**C. MEASUREMENT CIRCUIT:**

50 Ohm Test circuit ( single-ended / single-ended )

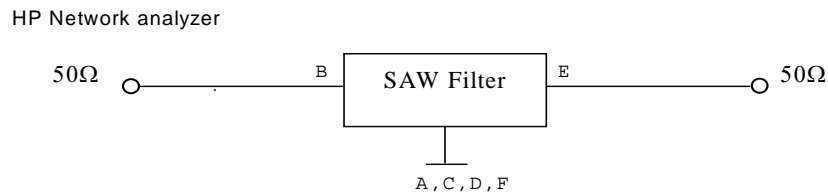

**D. OUTLINE DRAWING:**

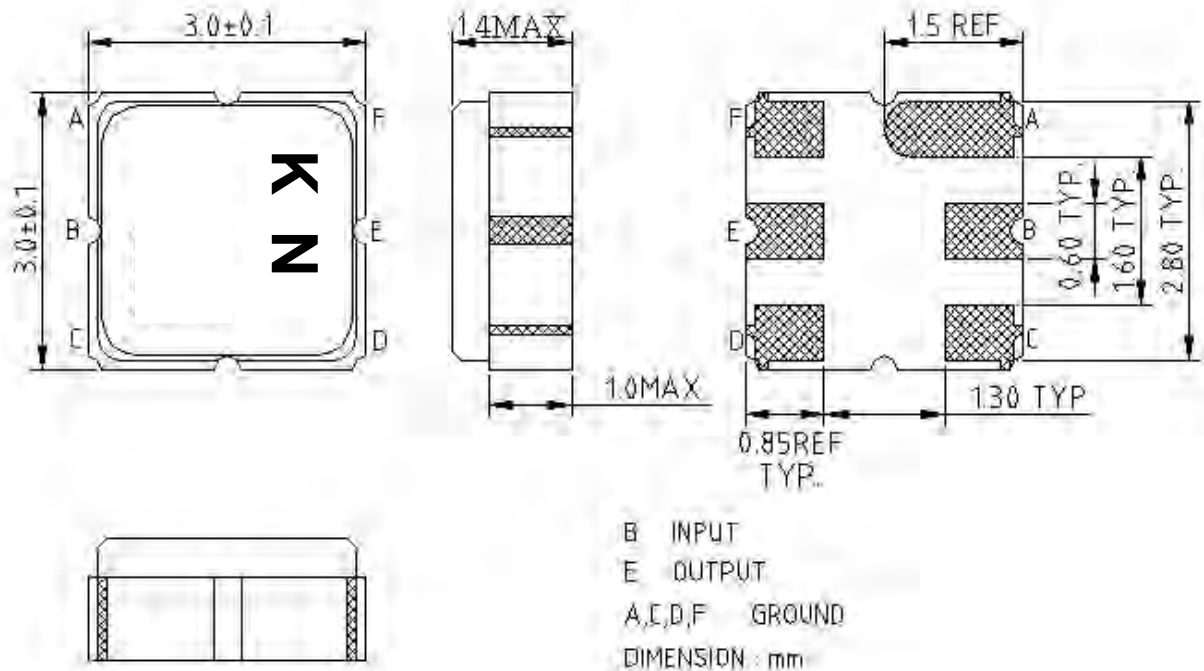

**E. PCB Footprint :**

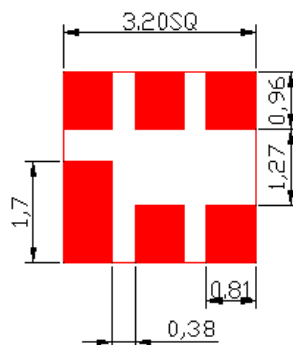

**SAW Filter 2375MHz**  
**Part No: MP03154**

**Model: TA1073A**  
**Rev No: 2**

**F. FREQUENCY CHARACTERISTICS:**

**Transfer function**

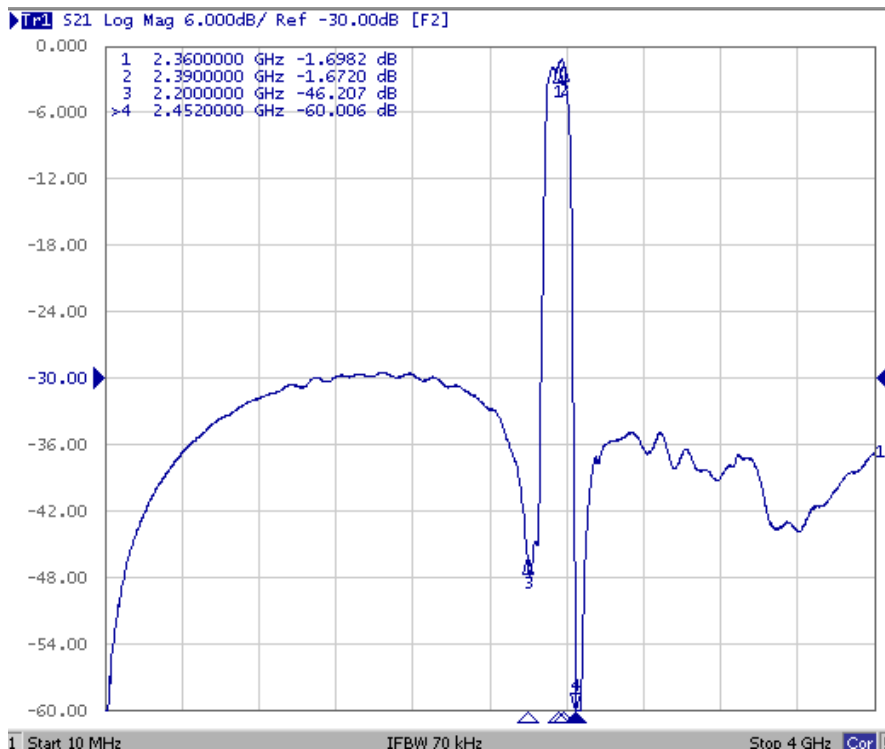
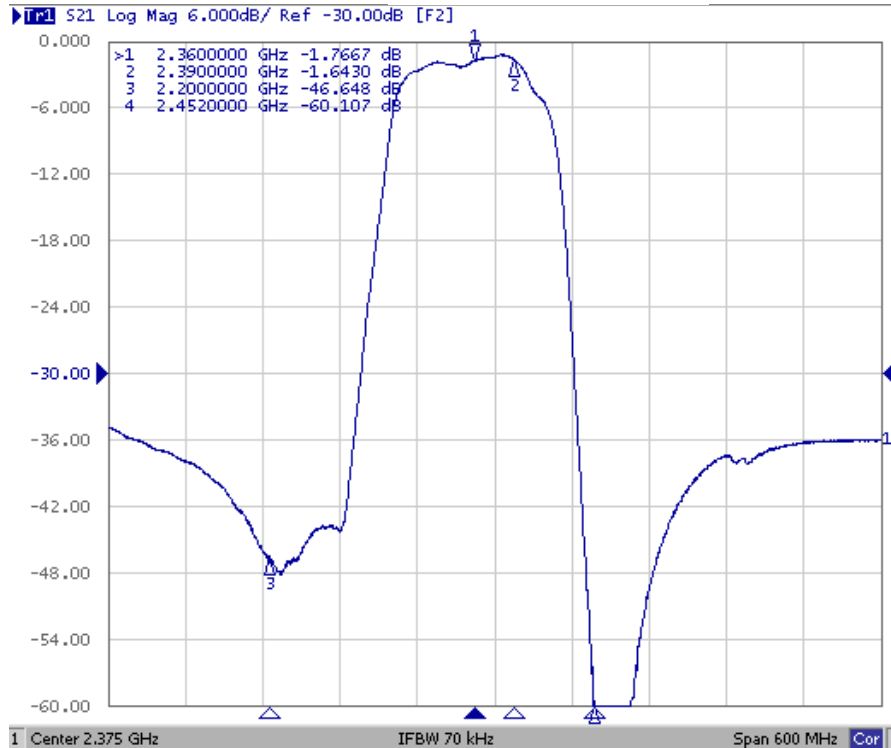

**SAW Filter 2375MHz**  
**Part No: MP03154**

**Model: TA1073A**  
**Rev No: 2**

**Reflection Function**

**S11**

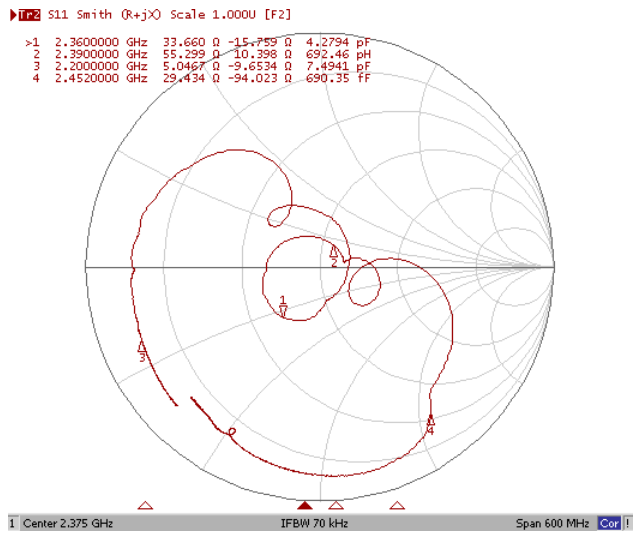
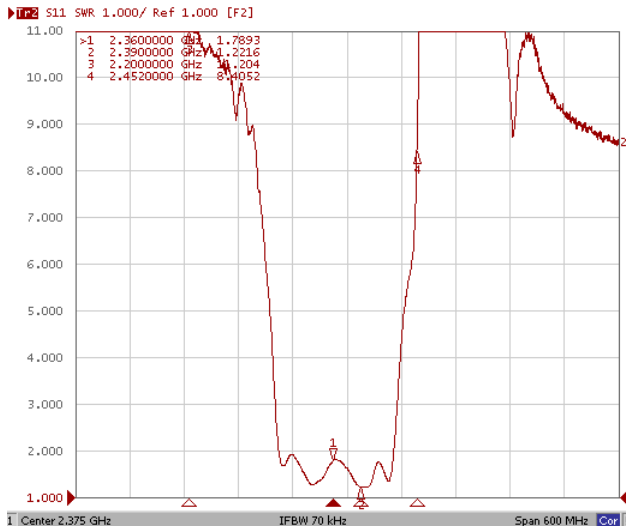

**S22**

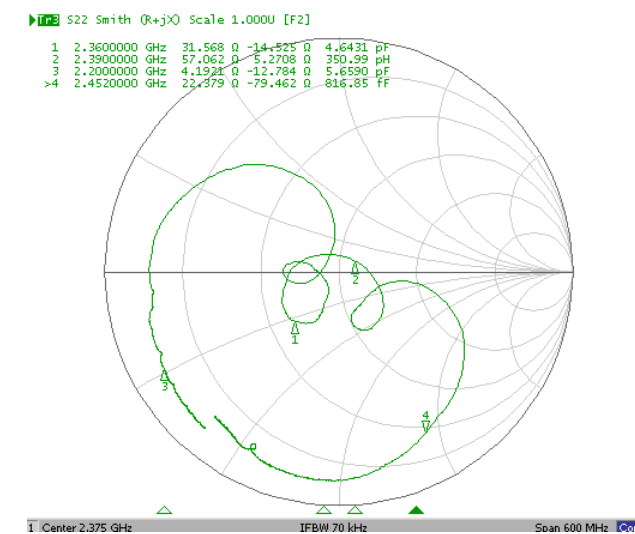
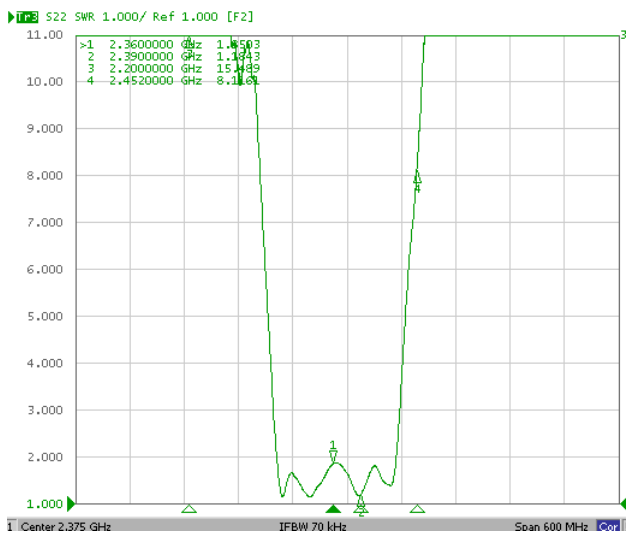

**SAW Filter 2375MHz**  
**Part No: MP03154**

**Model: TA1073A**  
**Rev No: 2**

**G. PACKING:**

**1. REEL DIMENSION**

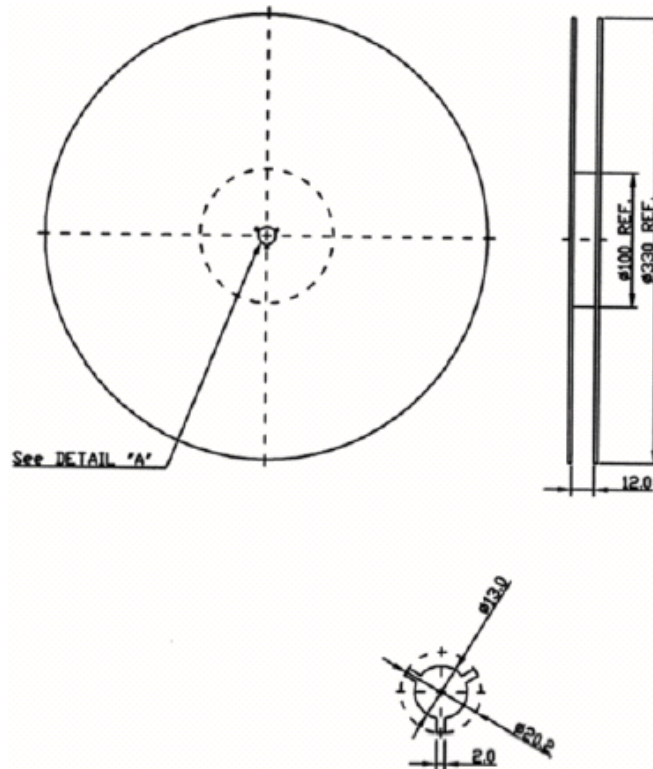

**2. TAPE DIMENSION**

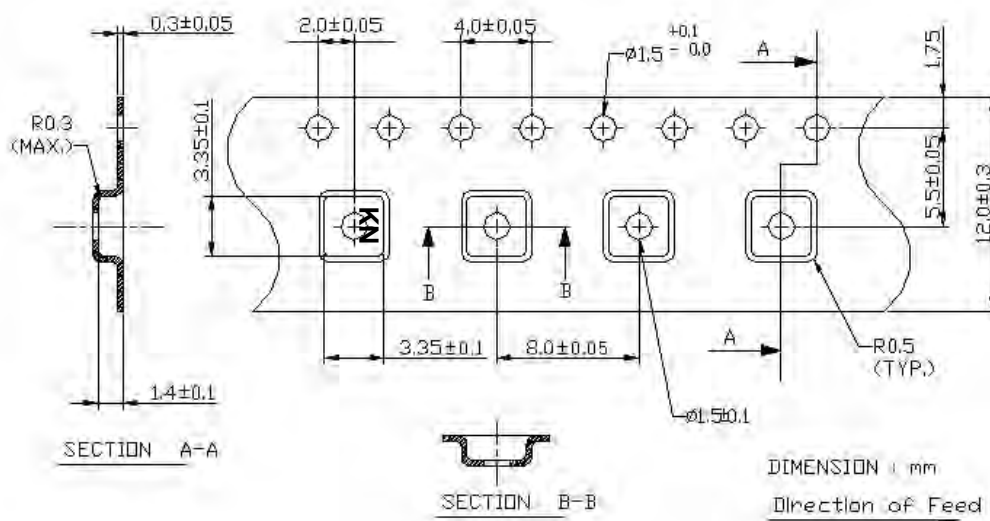

**SAW Filter 2375MHz**  
**Part No: MP03154**

**Model: TA1073A**  
**Rev No: 2**

**H. RECOMMENDED REFLOW PROFILE:**

