

SAW Filter 763MHz

Model: TA1130A

Part No: MP02447

REV NO.: 1

A. MAXIMUM RATING:

1. Input Power Level: +5 dBm
2. DC Voltage : 3V
3. Operating Temperature: -20°C to +70°C
4. Storage Temperature: -40°C to +85°C

B. ELECTRICAL CHARACTERISTICS:

Item	Unit	Min.	Type.	Max.	Note
Center Frequency Fc	MHz	-	763	-	-
Insertion Loss (758~768 MHz) IL	dB	-	1.3	3	-
Amplitude Ripple (758~768 MHz)	dB	-	0.3	1.5	-
Return Loss (758~768 MHz)	dB	10	15	-	-
Attenuation (Reference level from 0 dB)					
0 ~ 708 MHz	dB	30	41	-	-
788 ~ 798 MHz	dB	52	61	-	-
873 ~ 973 MHz	dB	40	43	-	-
1200 ~ 2000 MHz	dB	25	45	-	-

C. OUTLINE DRAWING:

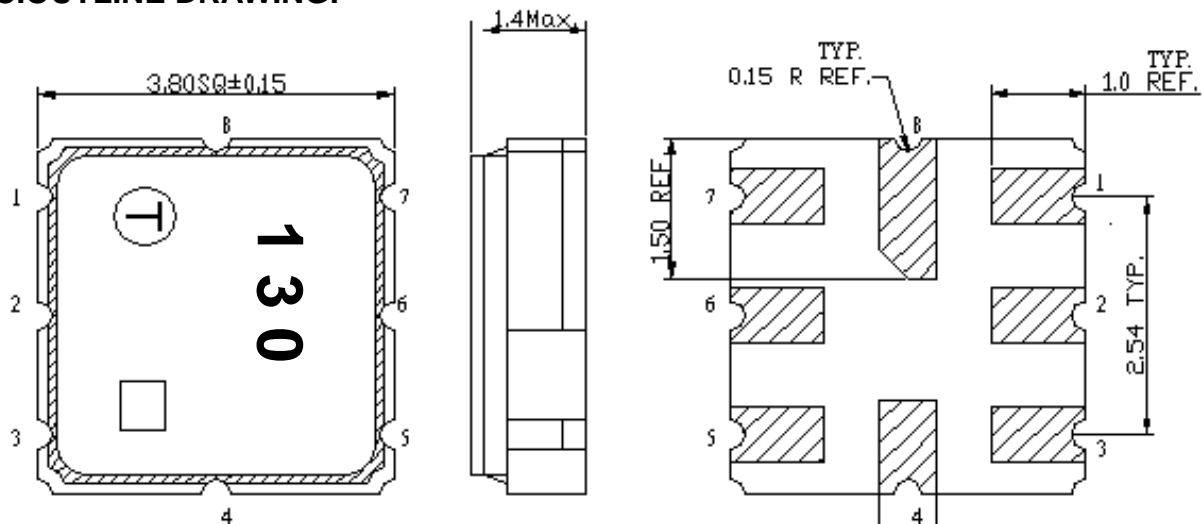

2 : Input
 6: Output
 1,3,4,5,7,8: Ground

SAW Filter 763MHz

Model: TA1130A

Part No: MP02447

REV NO.: 1

D. MEASUREMENT CIRCUIT:

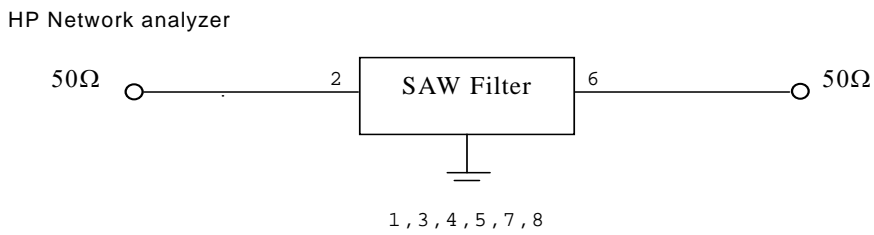

E. PCB FOOTPRINT:

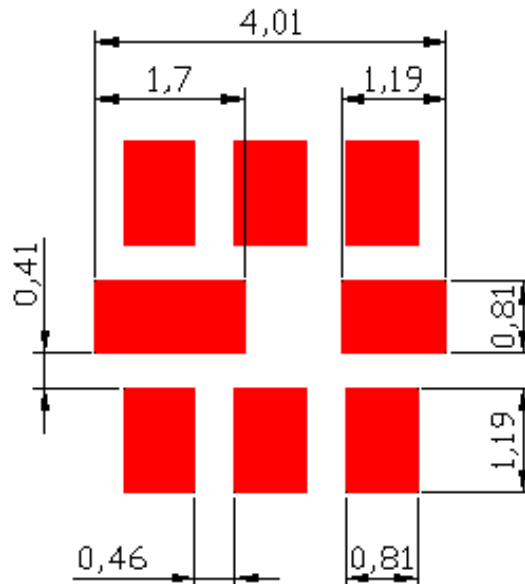

SAW Filter 763MHz

Model: TA1130A

Part No: MP02447

REV NO.: 1

F. FREQUENCY CHARACTERISTICS:

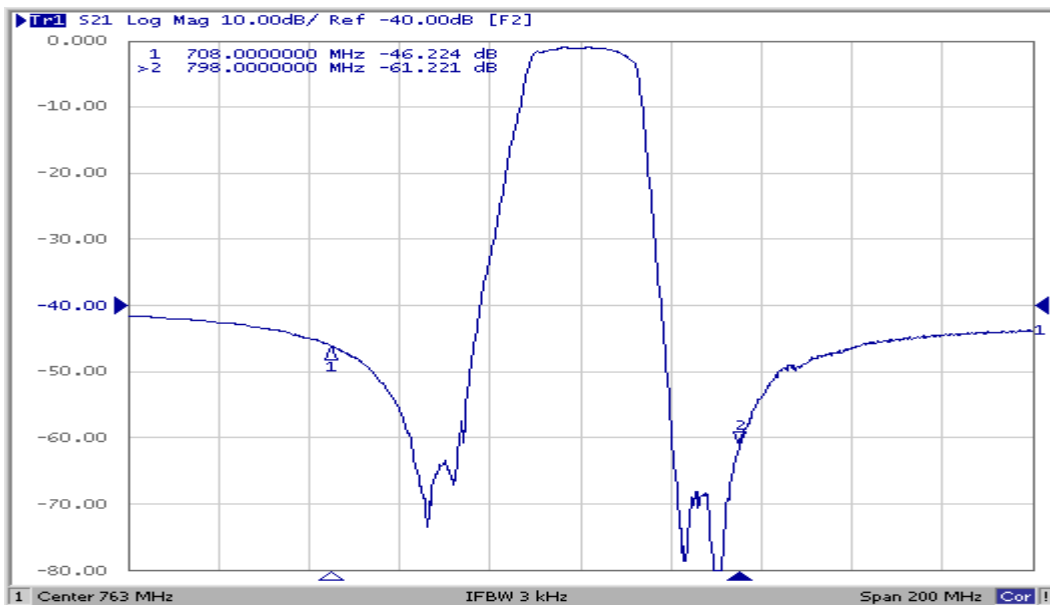
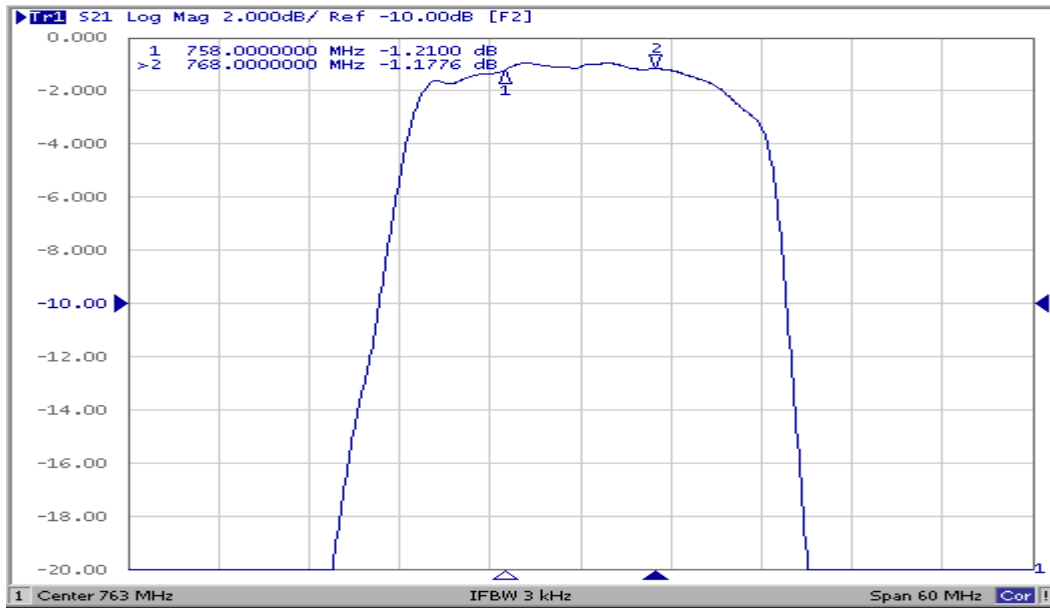

SAW Filter 763MHz
Part No: MP02447

Model: TA1130A
REV NO.: 1

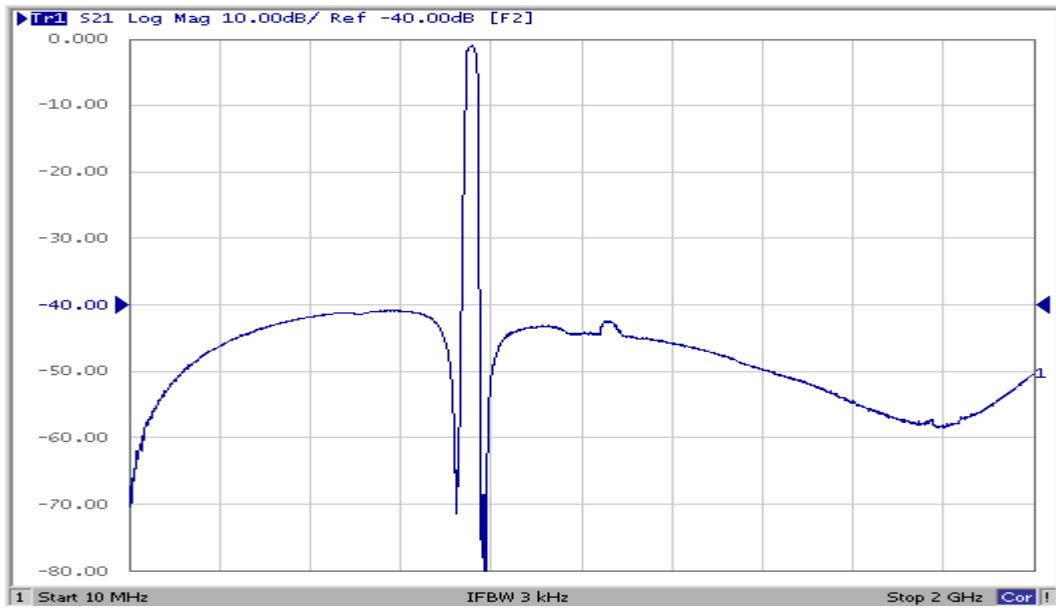

SAW Filter 763MHz
Part No: MP02447

Model: TA1130A
REV NO.: 1

Reflection Functions:

S11

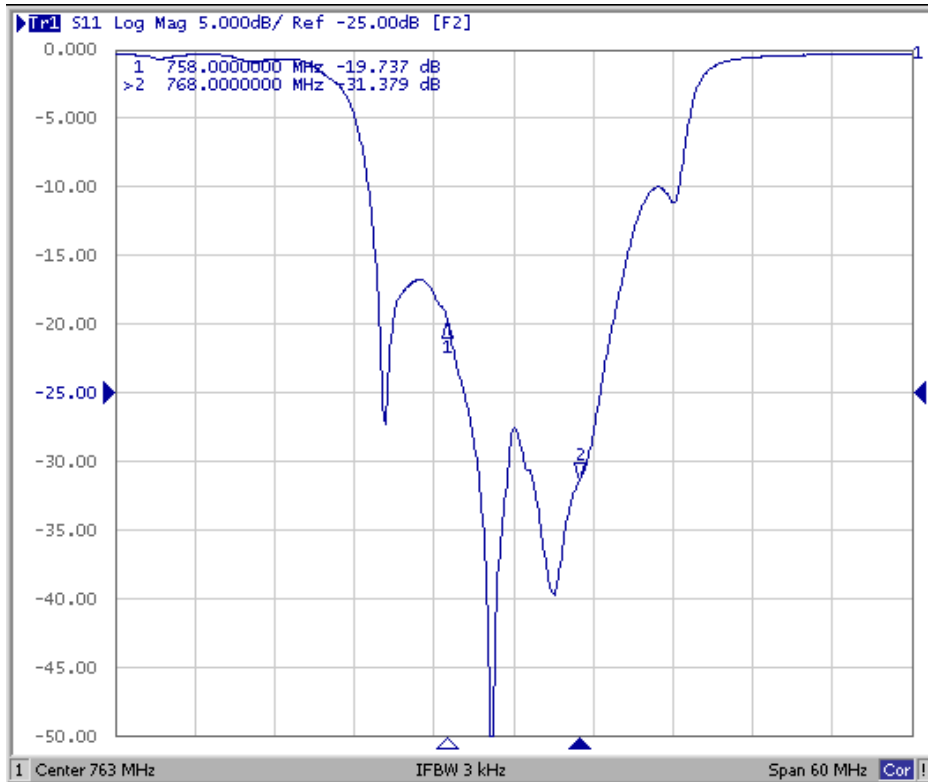

S22

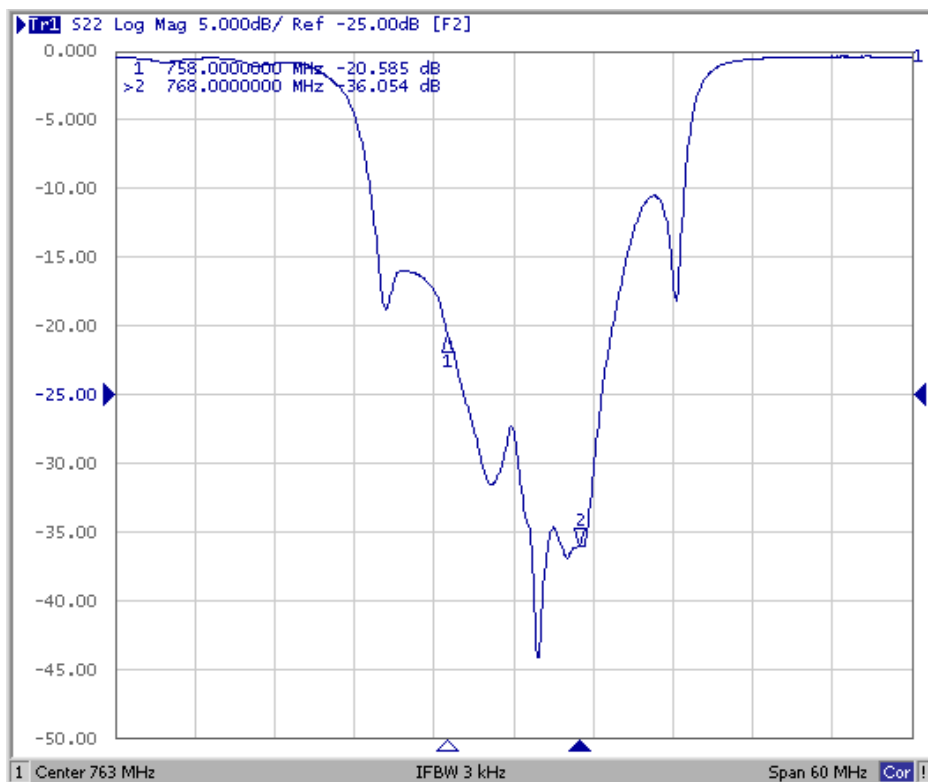

SAW Filter 763MHz

Model: TA1130A

Part No: MP02447

REV NO.: 1

H. RECOMMENDED REFLOW PROFILE :

