

SAW Filter 830.0MHz
Part No: MP02436

Model: TA0907A
Rev No: 1

A. MAXIMUM RATING:

1. Input Power Level: 10dBm
2. DC Voltage: 3V
3. Operating Temperature: -20°C to +70°C
4. Storage Temperature: -30°C to +85°C

B. ELECTRICAL CHARACTERISTICS:

Item	Unit	Min.	Typ.	Max.	Note
Center Frequency Fc	MHz	-	830	-	-
Insertion loss (825 ~ 835MHz) IL	dB	-	2.7	4.2	-
Amplitude Ripple (825 ~ 835MHz)	dB	-	0.5	2	-
VSWR (825 ~ 835MHz)		-	1.4	2.3	-
Attenuation (Reference level from 0 dB)					
0 ~ 795MHz	dB	35	57	-	-
865 ~ 1300MHz	dB	35	53	-	-

C. MEASUREMENT CIRCUIT:

HP Network analyzer

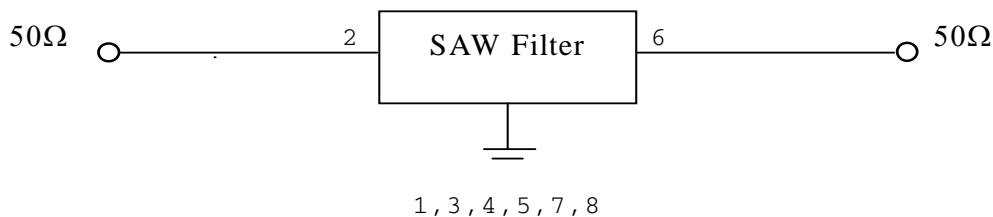

SAW Filter 830.0MHz
Part No: MP02436

Model: TA0907A
Rev No: 1

D. OUTLINE DRAWING:

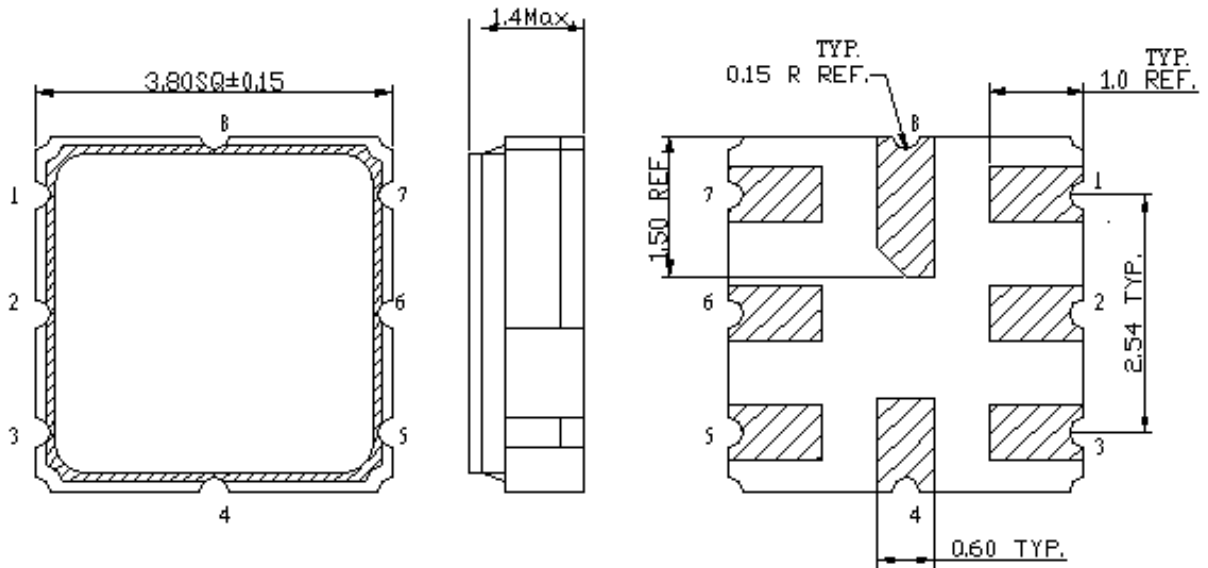

2: Input

6: Output

1, 3, 4, 5, 7, 8: Ground

Unit: mm

E. PCB FOOTPRINT:

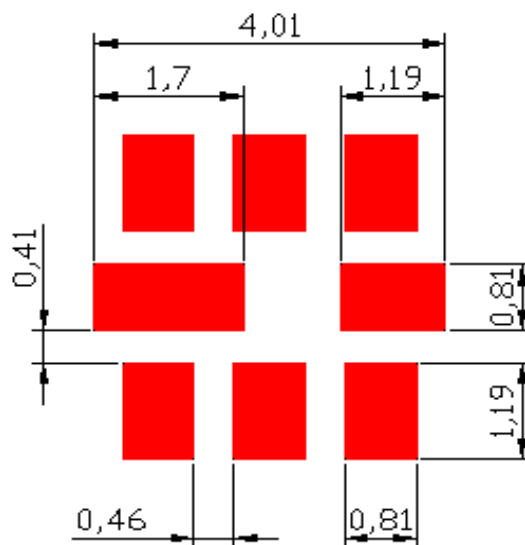

SAW Filter 830.0MHz
Part No: MP02436

Model: TA0907A
Rev No: 1

F. FREQUENCY CHARACTERISTICS:

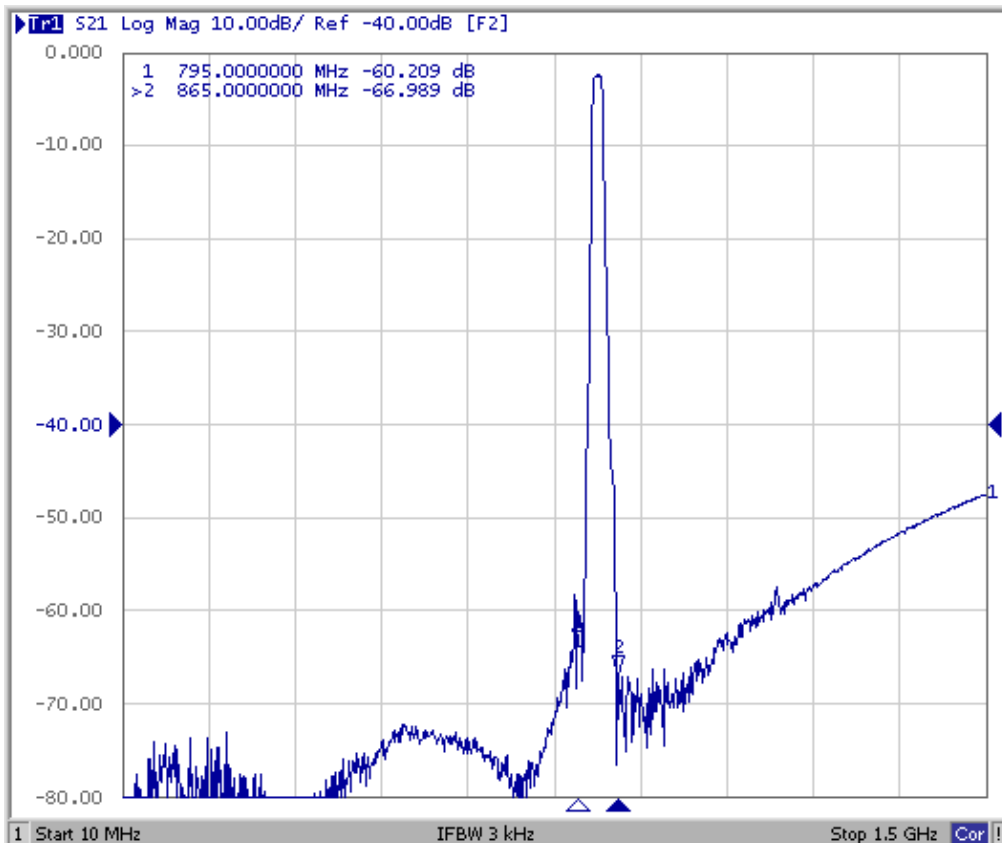
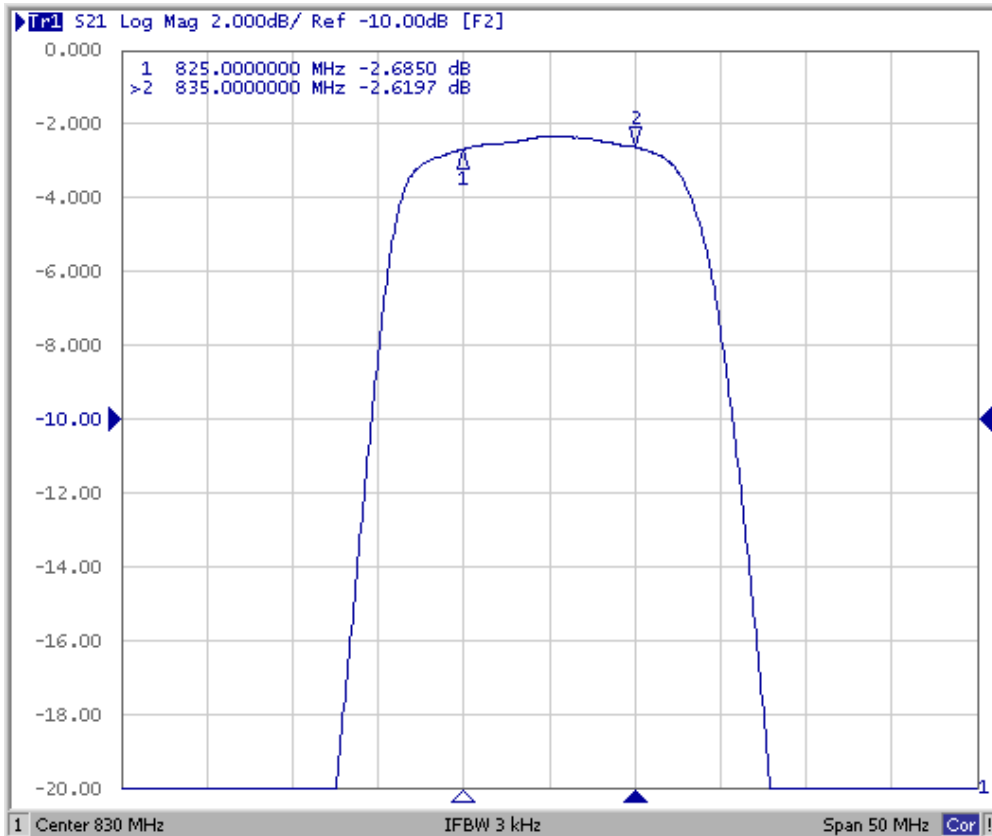

SAW Filter 830.0MHz
Part No: MP02436

Model: TA0907A
Rev No: 1

Reflection Functions

S11

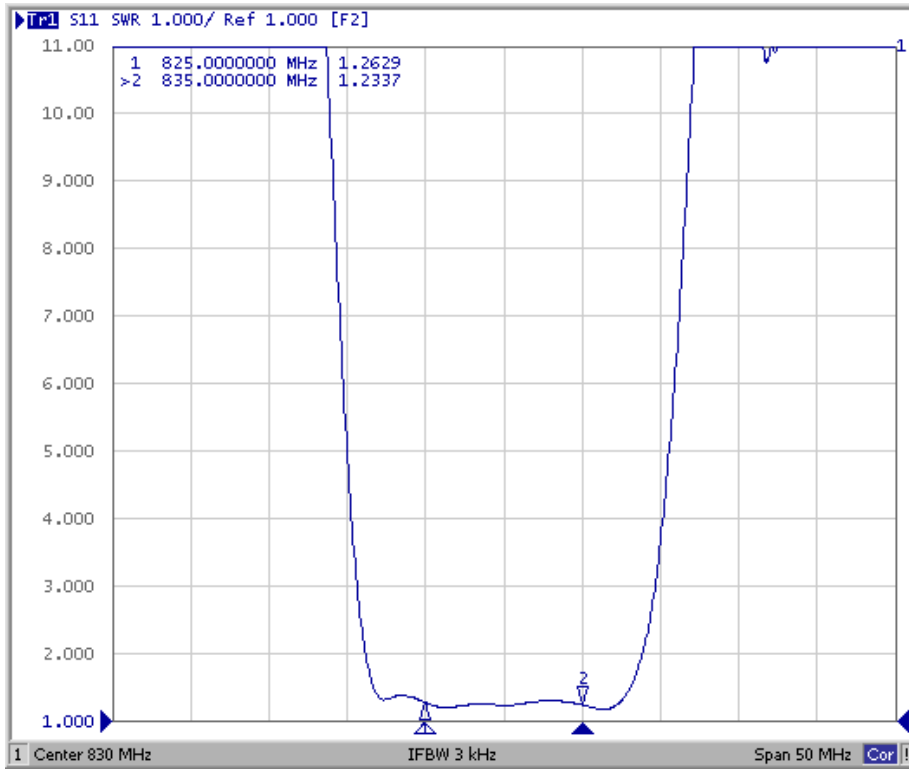

S22

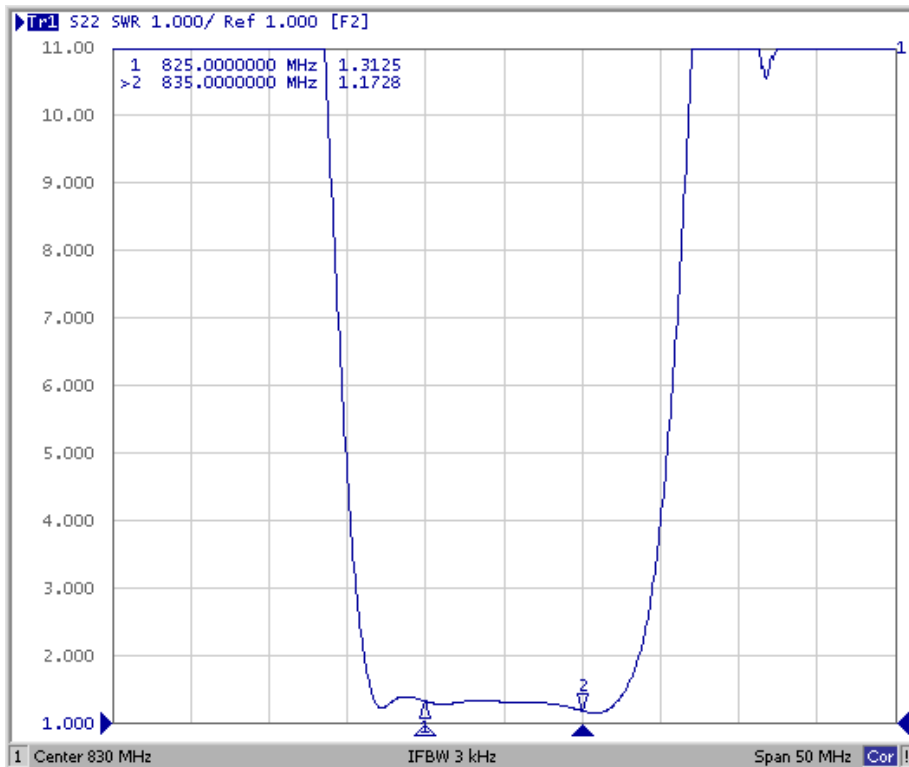

SAW Filter 830.0MHz
Part No: MP02436

Model: TA0907A
Rev No: 1

G. PACKING:

1. Reel Dimension (Reel Count: 7"=1000, 13"=3000)

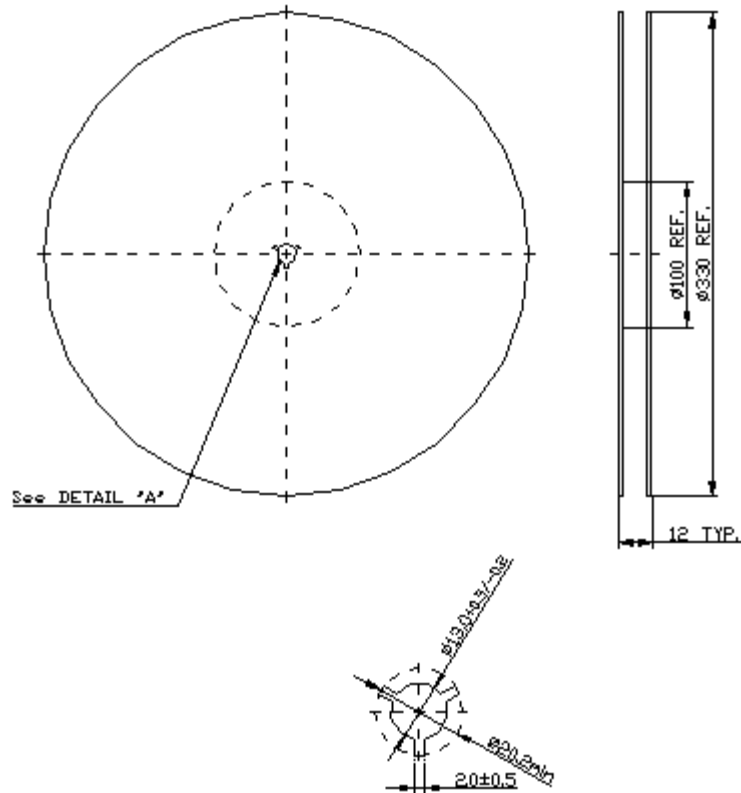

2. Tape Dimension

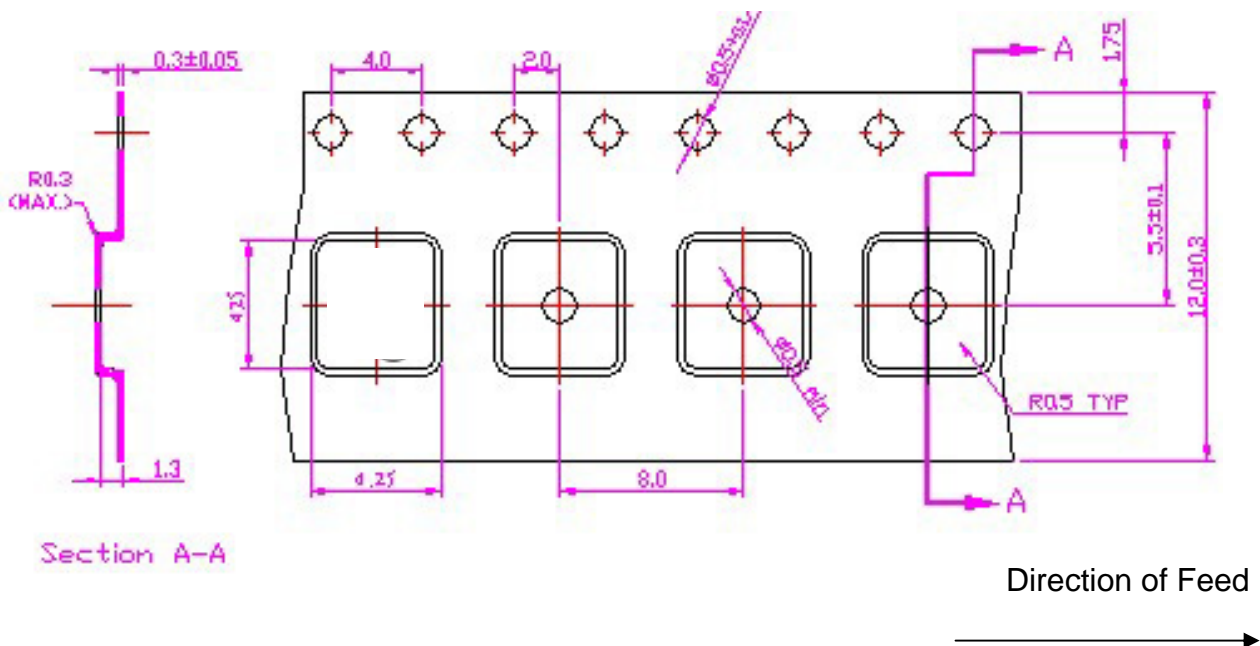

SAW Filter 830.0MHz
Part No: MP02436

Model: TA0907A
Rev No: 1

H. RECOMMENDED REFLOW PROFILE:

