

SAW Filter 647.0MHz

Model: TA1007A

Part No: MP02295

REV NO.: 1

A. MAXIMUM RATING:

1. Input Power Level: 10 dBm
2. DC Voltage : 3V
3. Operating Temperature: -20°C to +75°C
4. Storage Temperature: -40°C to +85°C

B. ELECTRICAL CHARACTERISTICS:

Item	Unit	Min.	Typ.	Max.
Center frequency Fc	MHz	-	647	-
Insertion loss (638~656 MHz) IL	dB	-	2.5	4.5
Amplitude Ripple (variation over 6MHz)	dB	-	0.7	1.0
Group Delay Variation (638~656 MHz)	ns	-	26	45
Attenuation (Reference level from 0 dB)				
0 ~ 560 MHz	dB	30	54	-
560 ~ 590 MHz	dB	45	52	-
720 ~ 1000 MHz	dB	30	50	-
1000 ~ 1500 MHz	dB	30	38	-
Temperature Coefficient of Frequency	ppm/°C	-	-35	-

C. MEASUREMENT CIRCUIT:

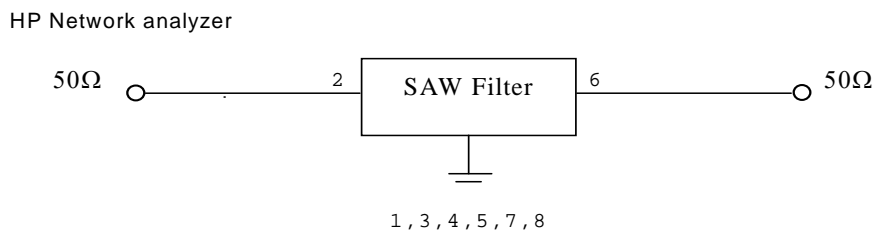

SAW Filter 647.0MHz

Model: TA1007A

Part No: MP02295

REV NO.: 1

D. OUTLINE DRAWING:

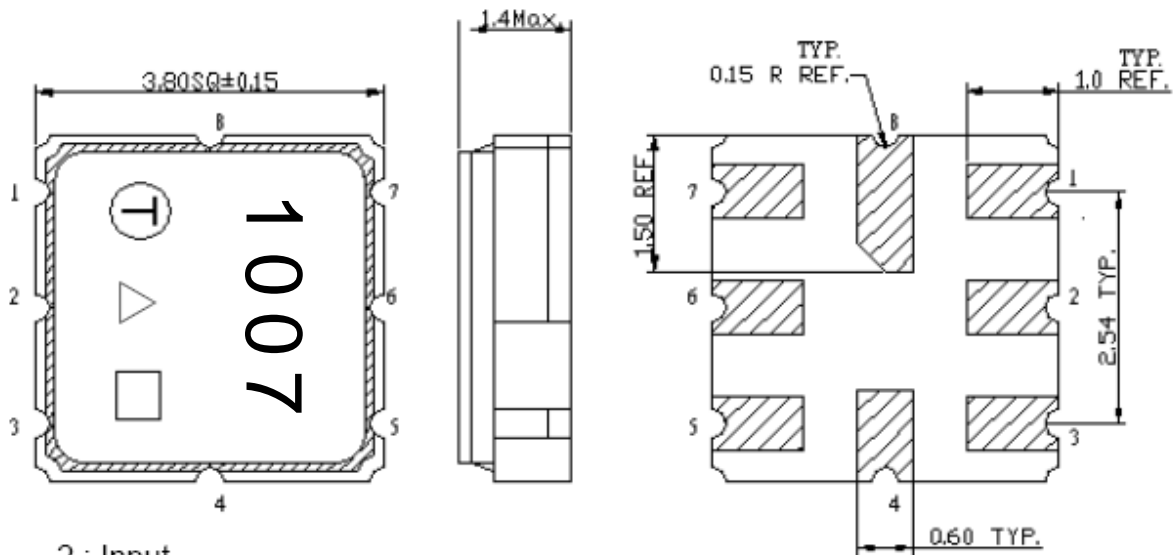

- 2 : Input
- 6: Output
- 1,3,4,5,7,8: Ground
- △ : Year Code
- : Date Code (W01->A, W02->B, ..., W52->z)

△ Product Year Code

Year	2007	2008
	2009	2010
	2011	2012
Product Code	A	a

E. PCB FOOTPRINT:

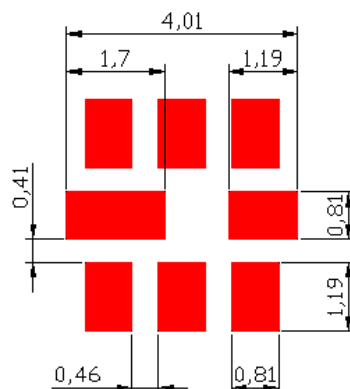

SAW Filter 647.0MHz
Part No: MP02295

Model: TA1007A
REV NO.: 1

F. FREQUENCY CHARACTERISTICS:

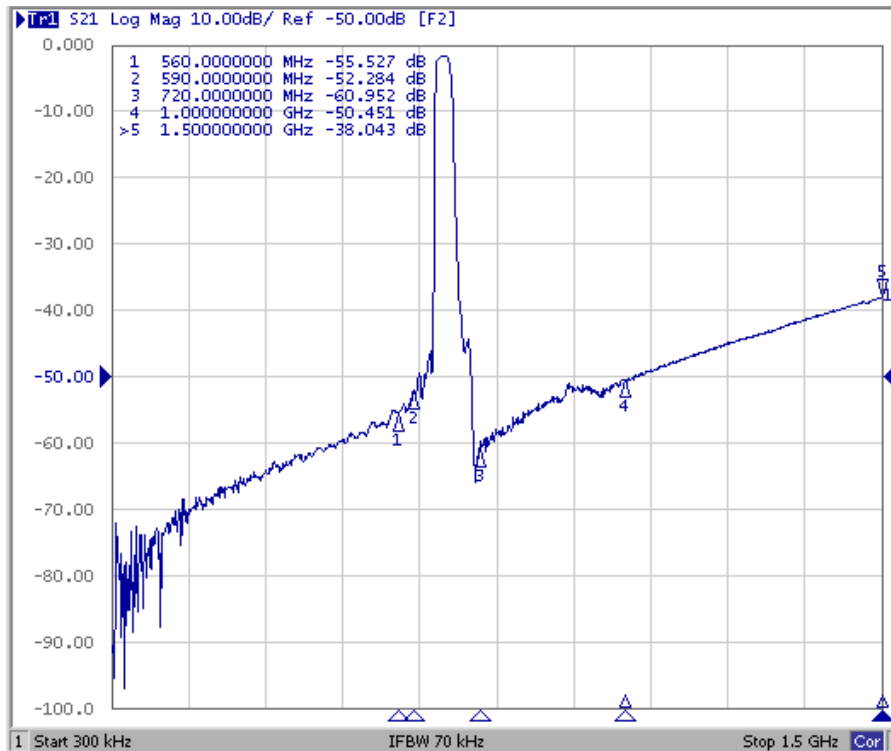
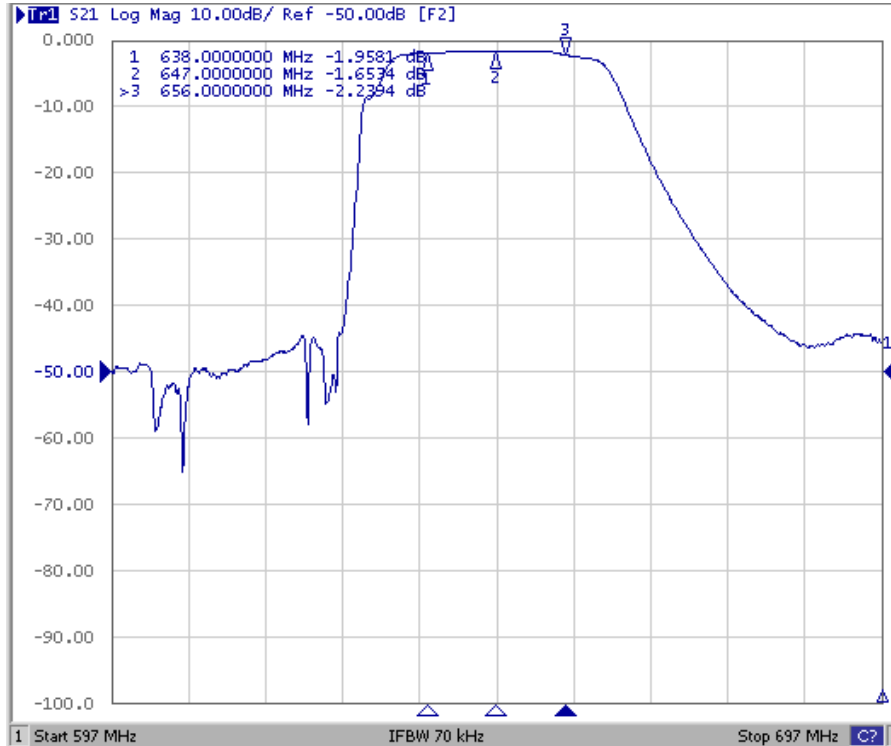

SAW Filter 647.0MHz
Part No: MP02295

Model: TA1007A
REV NO.: 1

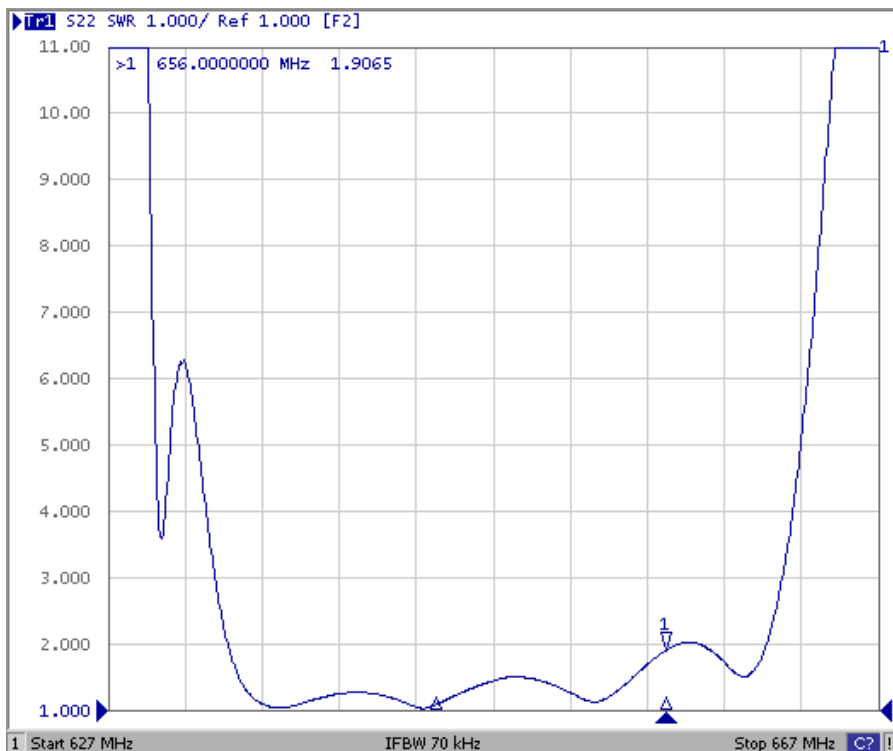
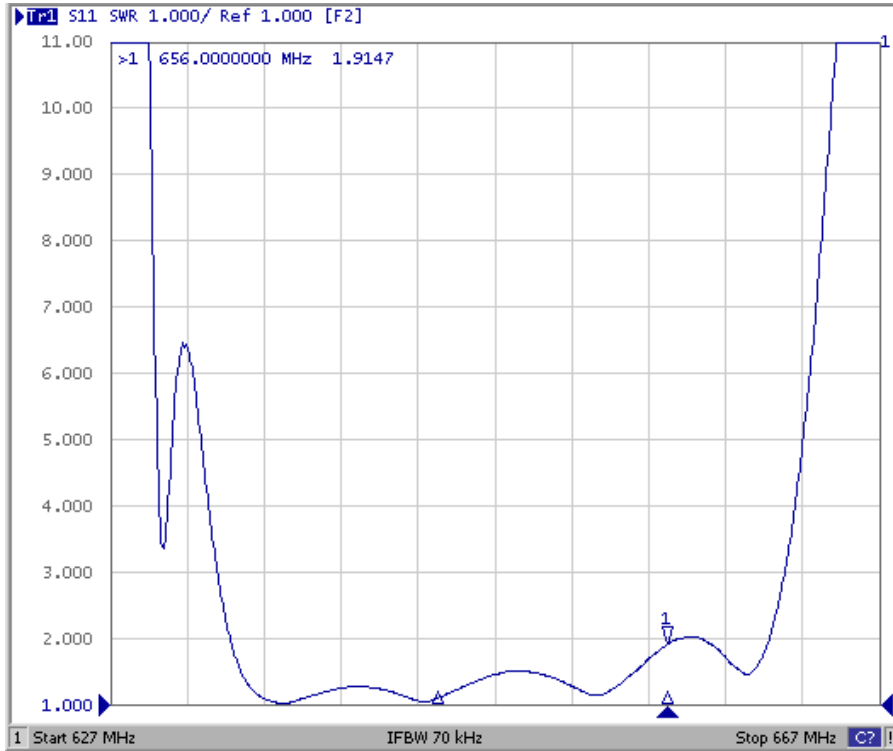

SAW Filter 647.0MHz
Part No: MP02295

Model: TA1007A
REV NO.: 1



SAW Filter 647.0MHz

Model: TA1007A

Part No: MP02295

REV NO.: 1

G. PACKING:

1. REEL DIMENSION

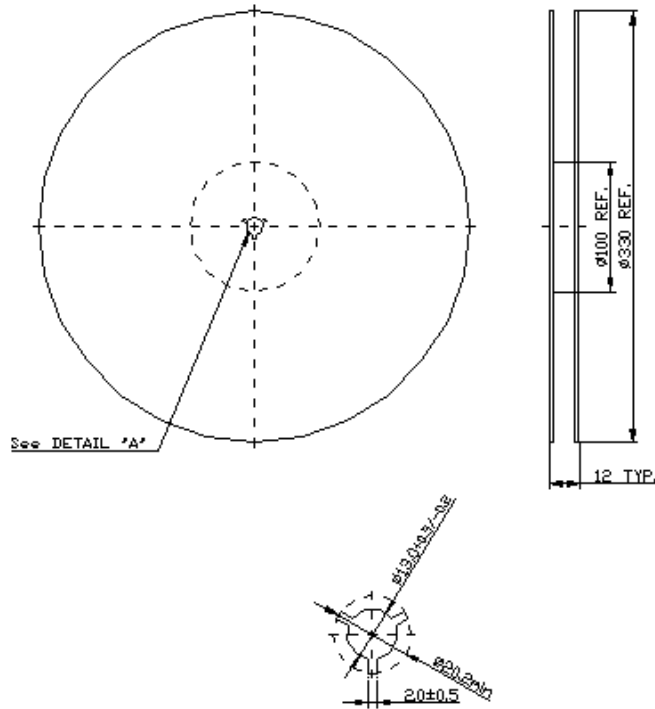

2. TAPE DIMENSION

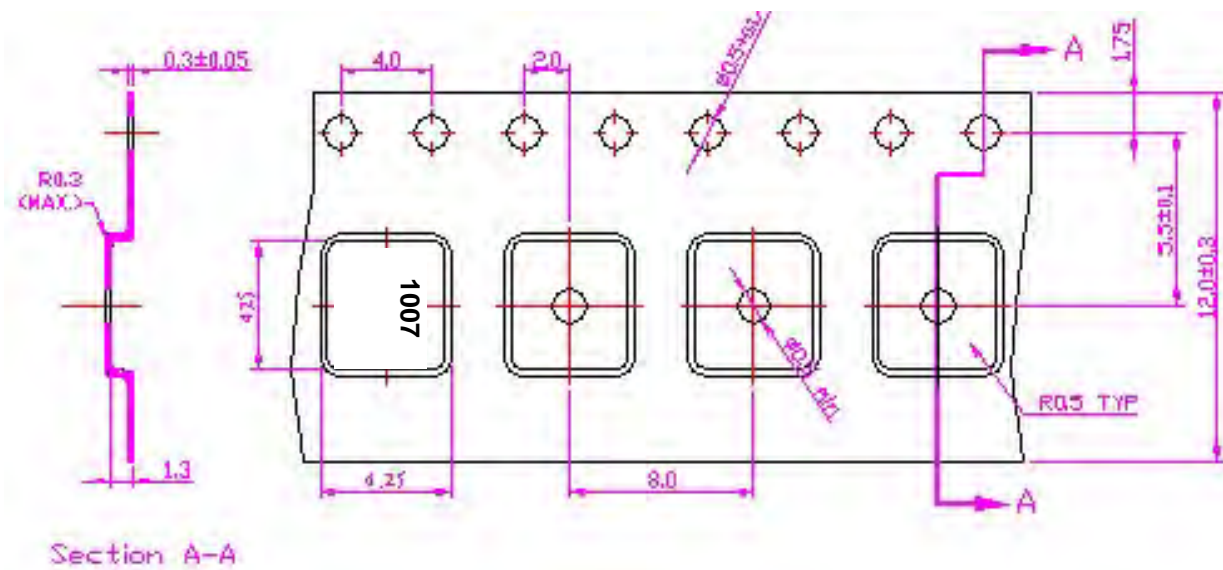

SAW Filter 647.0MHz

Model: TA1007A

Part No: MP02295

REV NO.: 1

H. RECOMMENDED REFLOW PROFILE:

