

SAW Filter 2675.0MHz

Model: TA0761A

Part No: MP02040

Rev No: 1

A. MAXIMUM RATING:

1. Input Power Level: 10 dBm
2. DC Voltage: 3V
3. Operating Temperature: -30°C to +85°C
4. Storage Temperature: -40°C to +95°C

B. ELECTRICAL CHARACTERISTICS:

Item	Unit	Min.	Typ.	Max.	Note
Center Frequency Fc	MHz	-	2675	-	-
Insertion Loss (2660 ~ 2690MHz) IL	dB	-	2.8	3.5	-
Amplitude Ripple (2660 ~ 2690MHz)	dB	-	0.8	2.2	-
Return Loss (2660 ~ 2690MHz)	dB	9	22	-	-
Attenuation (Reference level from 0dB)					
2100 ~ 2550MHz	dB	35	42	-	-
2770 ~ 2930MHz	dB	40	50	-	-
2930 ~ 3100MHz	dB	35	45	-	-

C. MEASUREMENT CIRCUIT:

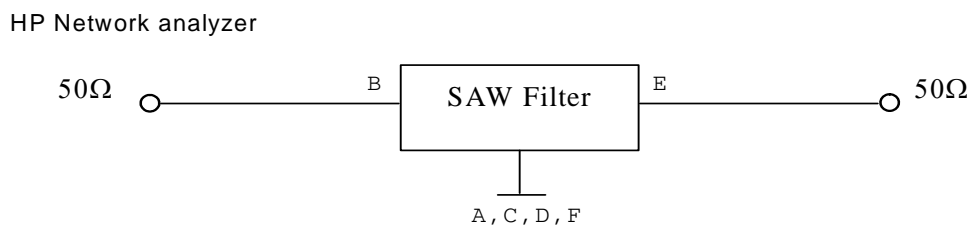

SAW Filter 2675.0MHz
Part No: MP02040

Model: TA0761A
Rev No: 1

D. OUTLINE DRAWING:

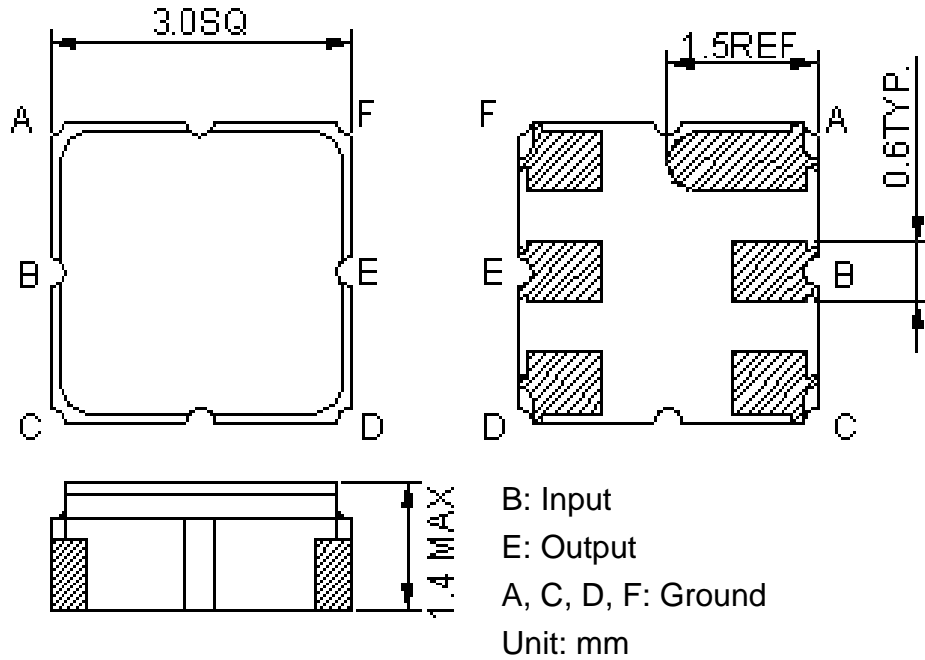

E. PCB FOOTPRINT:

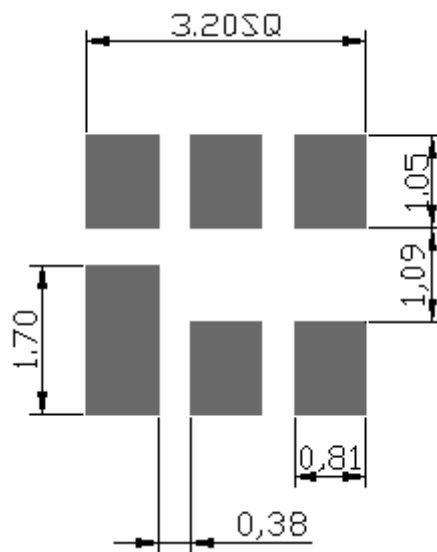

SAW Filter 2675.0MHz
Part No: MP02040

Model: TA0761A
Rev No: 1

F. FREQUENCY CHARACTERISTICS:

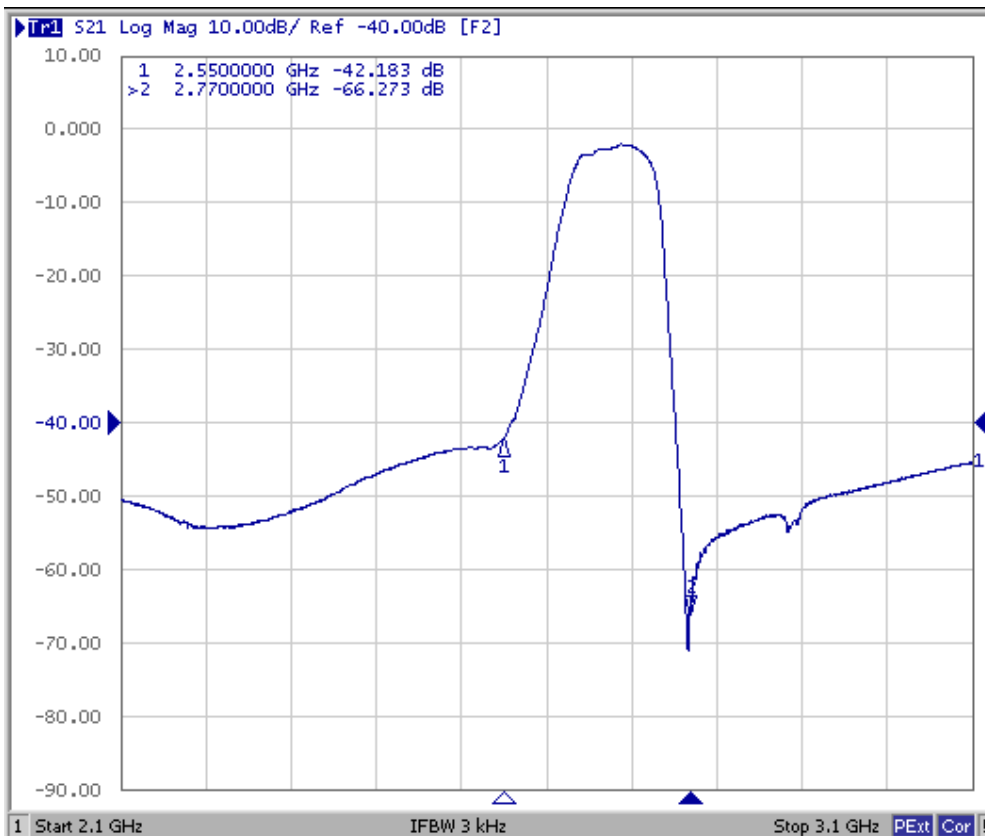
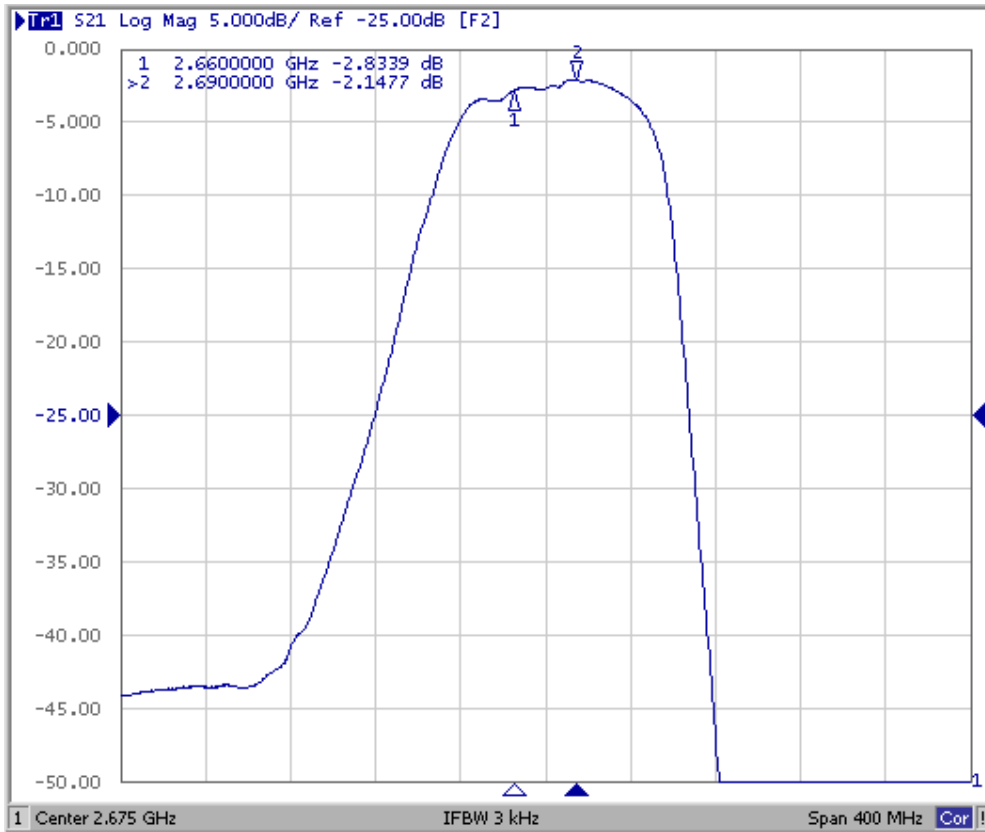

SAW Filter 2675.0MHz
Part No: MP02040

Model: TA0761A
Rev No: 1

Reflection Functions

S11

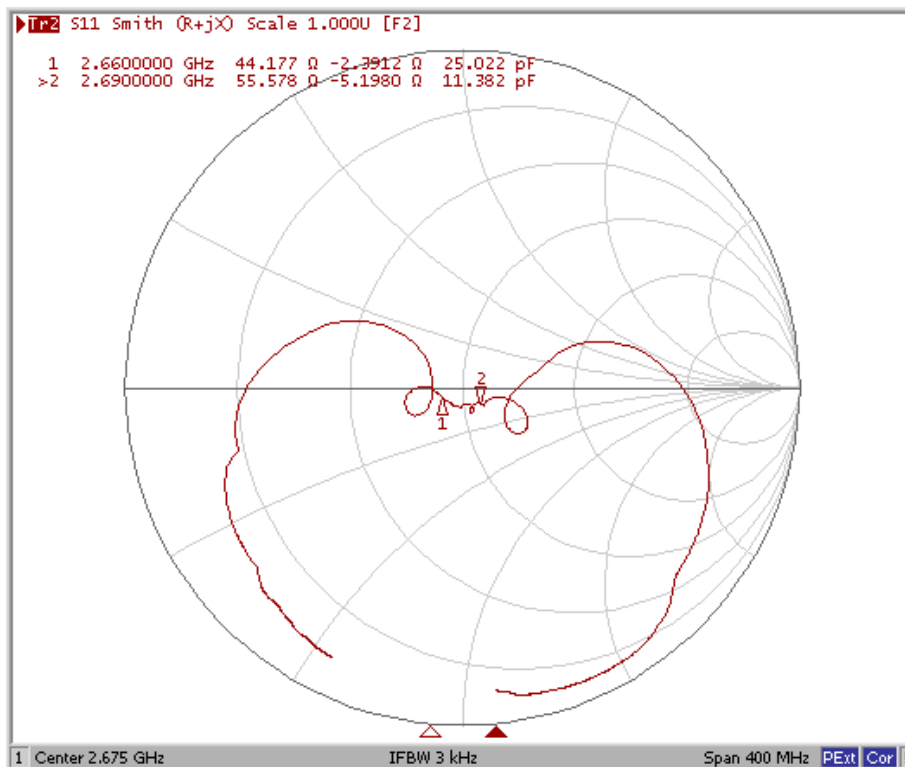
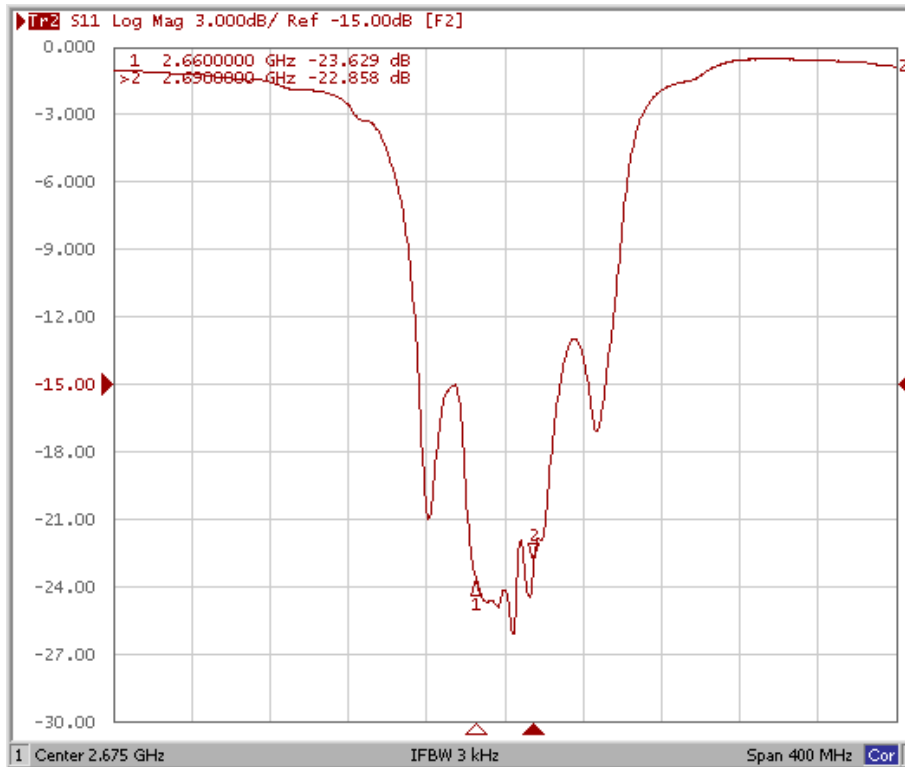

SAW Filter 2675.0MHz
Part No: MP02040

Model: TA0761A
Rev No: 1

S22

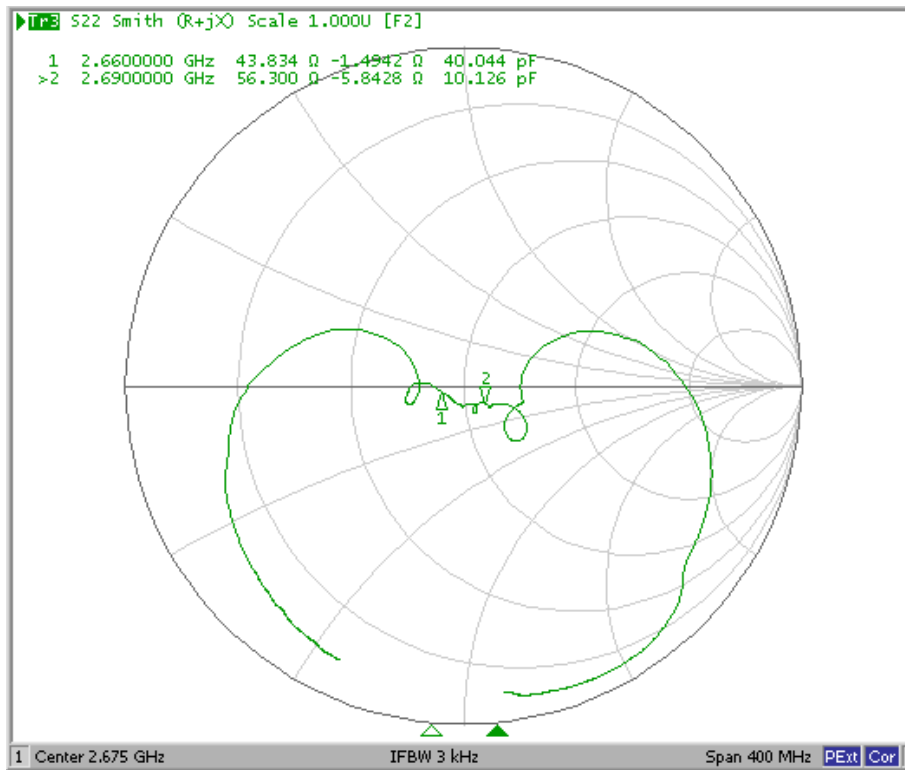
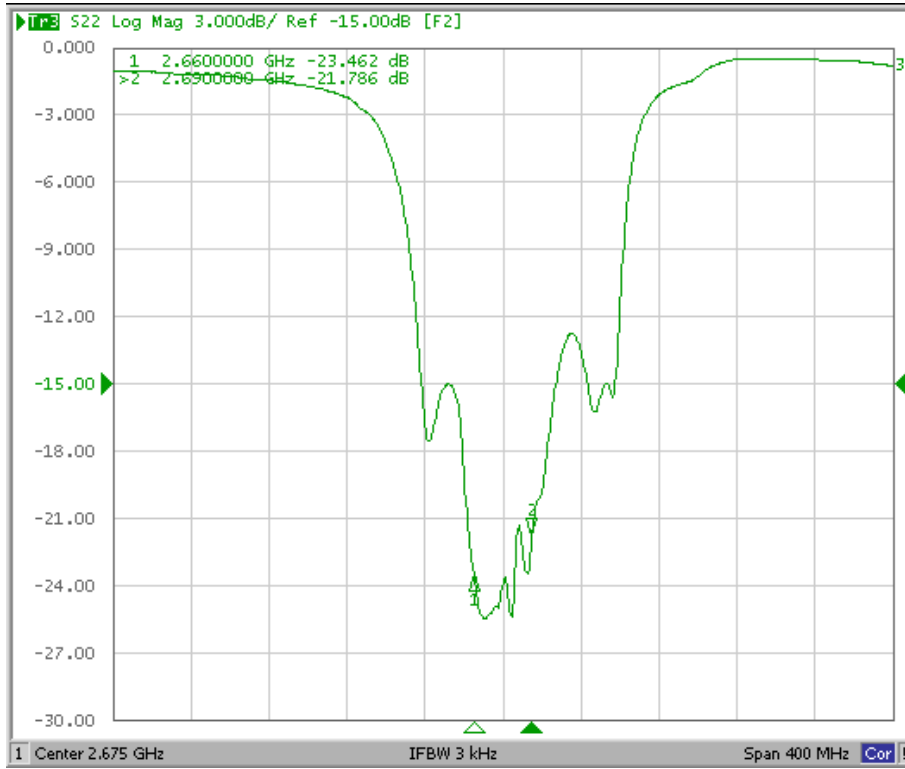

SAW Filter 2675.0MHz
Part No: MP02040

Model: TA0761A
Rev No: 1

G. PACKING:

1. Reel Dimension (Reel Count: 7" = 1000; 13" = 3000)

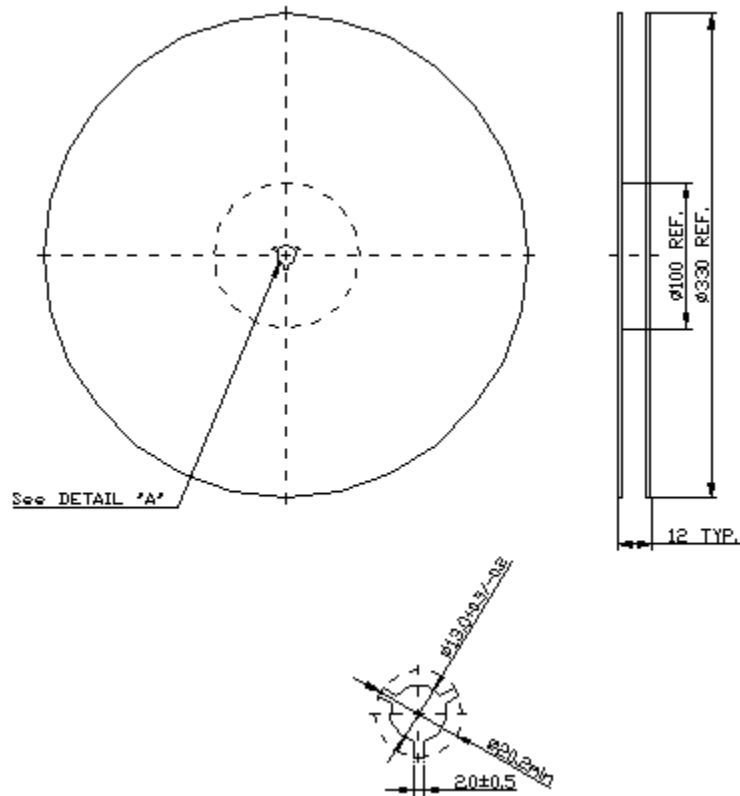

2. Tape Dimension

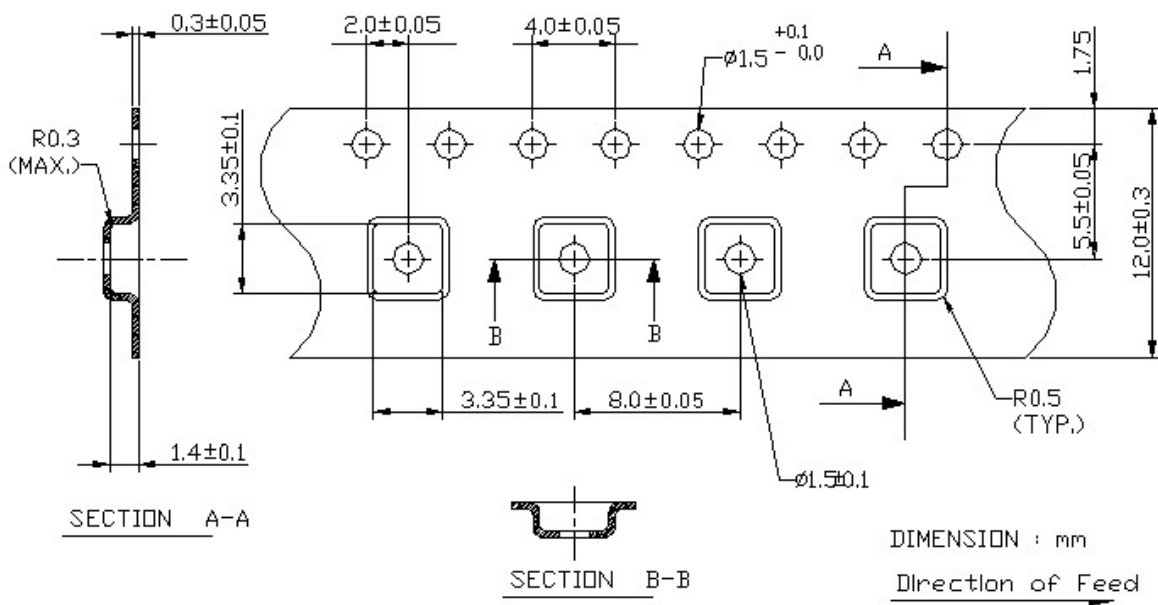

SAW Filter 2675.0MHz
Part No: MP02040

Model: TA0761A
Rev No: 1

H. RECOMMENDED REFLOW PROFILE:

