

**2160.0MHz SAW Filter**

**Model: TA0465A**

**Part No: MA09944**

**REV NO.: 1**

**A. MAXIMUM RATING:**

1. Input Power Level: 5 dBm
2. DC voltage: 0 V
3. Operating Temperature: -30°C to +80°C
4. Storage Temperature: -40°C to +85°C

**B. ELECTRICAL CHARACTERISTICS:**

Item	Min.	Typ.	Max.
Center frequency Fc (MHz)	-	2160	-
Insertion loss (2130~2190 MHz) IL (dB)	-	2.2	3.5
Amplitude ripple (2130~2190 MHz) (dB)	-	1.0	2.0
Attenuation (Reference level from 0 dB)			
D.C. ~ 500 MHz (dB)	21	34	-
500 ~ 1900 MHz (dB)	20	29	-
1900 ~ 2050 MHz (dB)	25	33	-
2070 MHz (dB)	40	47	-
2240 ~ 2300 MHz (dB)	20	40	-
2300 ~ 4500 MHz (dB)	22	32	-
Input/Output VSWR (2130~2170 MHz)	-	1.9	2.3
Source impedance Zs (Ω)	-	50	-
Load impedance ZL (Ω)	-	50	-

Note1. The standard definitions is in JIS C 6703

**C. MEASUREMENT CIRCUIT:**

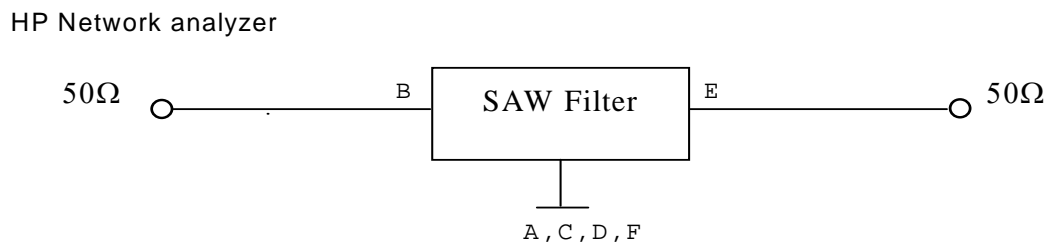

**2160.0MHz SAW Filter**  
**Part No: MA09944**

**Model: TA0465A**  
**REV NO.: 1**

**D. OUTLINE DRAWING:**

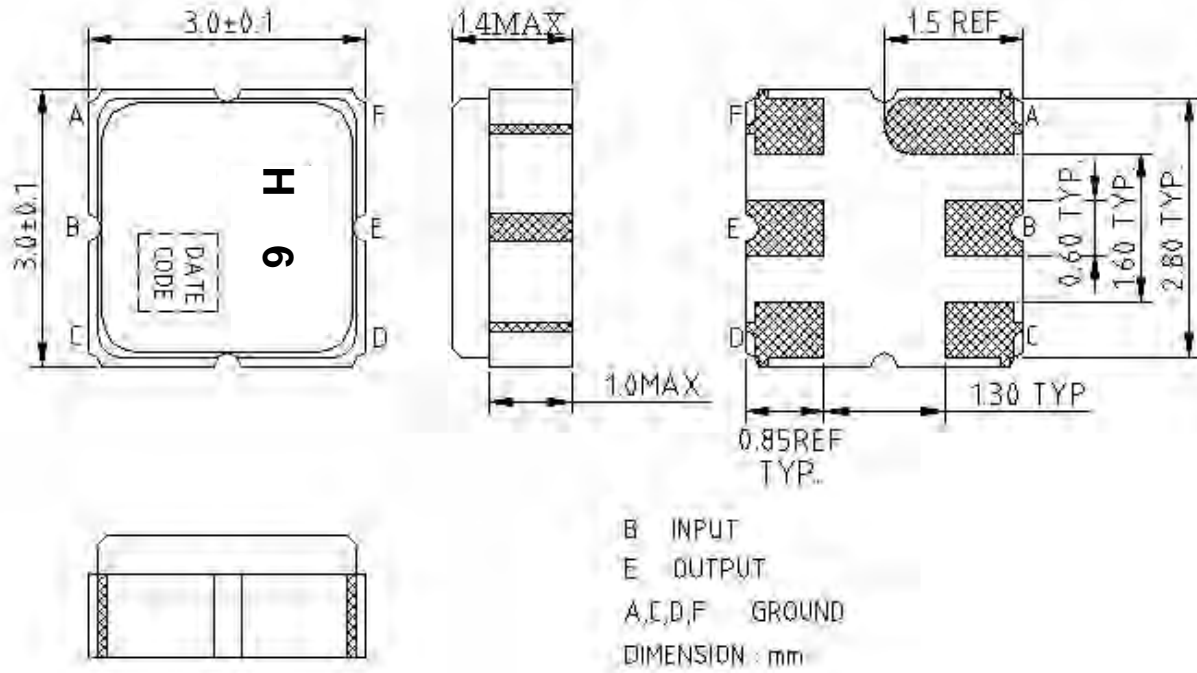

**E. PCB FOOTPRINT:**

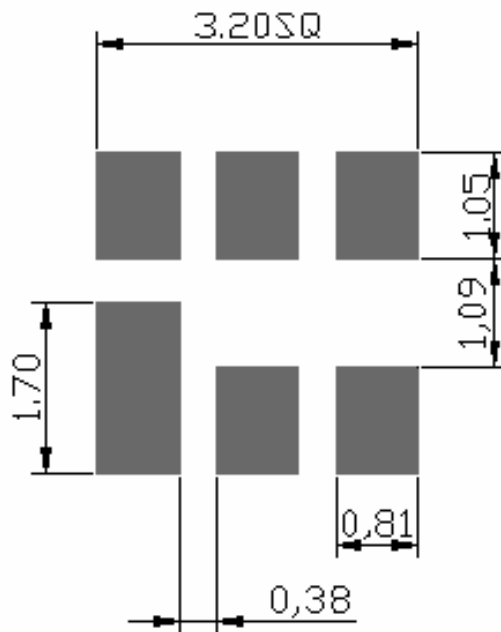

**2160.0MHz SAW Filter**  
**Part No: MA09944**

**Model: TA0465A**  
**REV NO.: 1**

**F. FREQUENCY CHARACTERISTICS:**

**Transfer function**

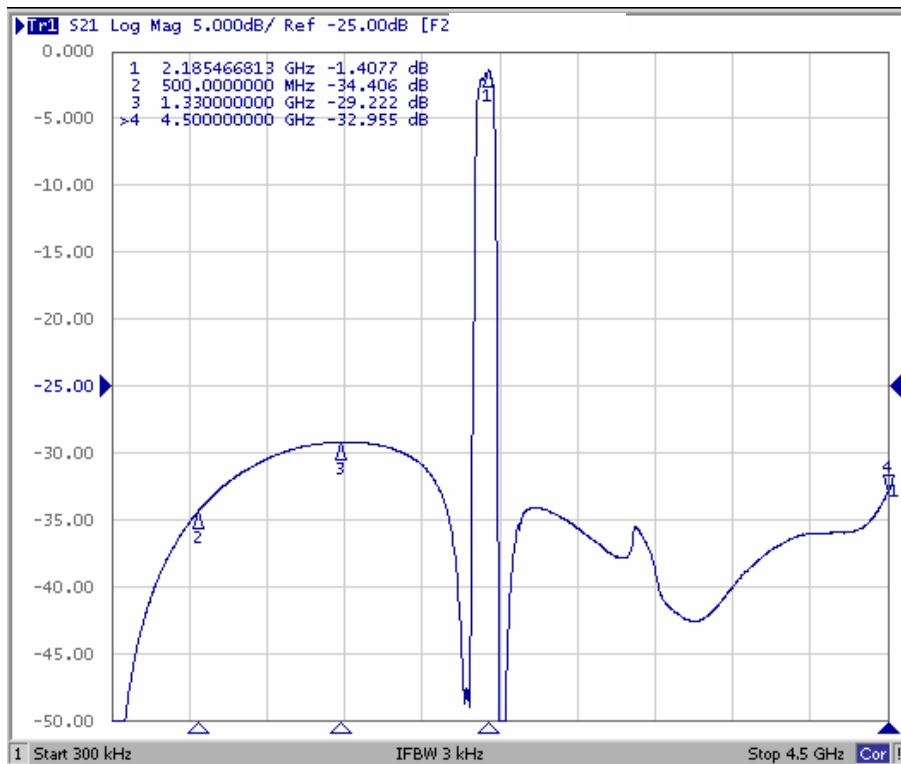
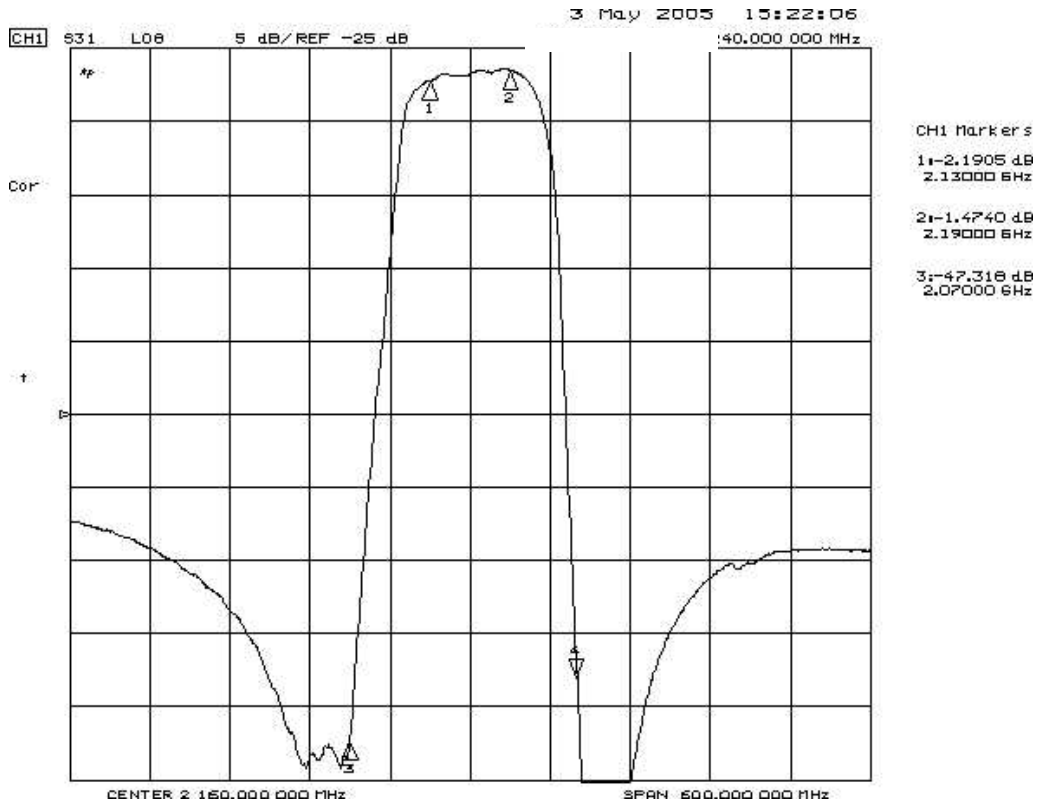

**2160.0MHz SAW Filter**  
**Part No: MA09944**

**Model: TA0465A**  
**REV NO.: 1**

**Reflections Functions :**

**S11**

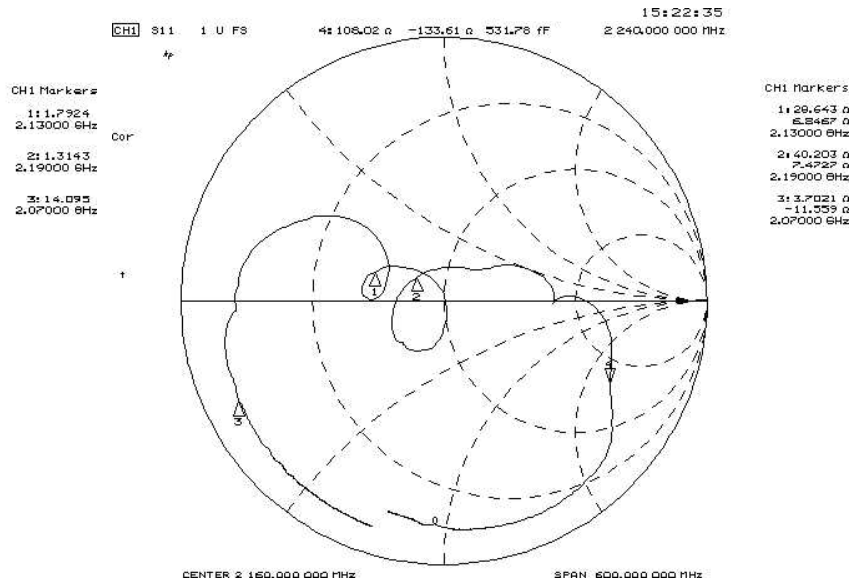
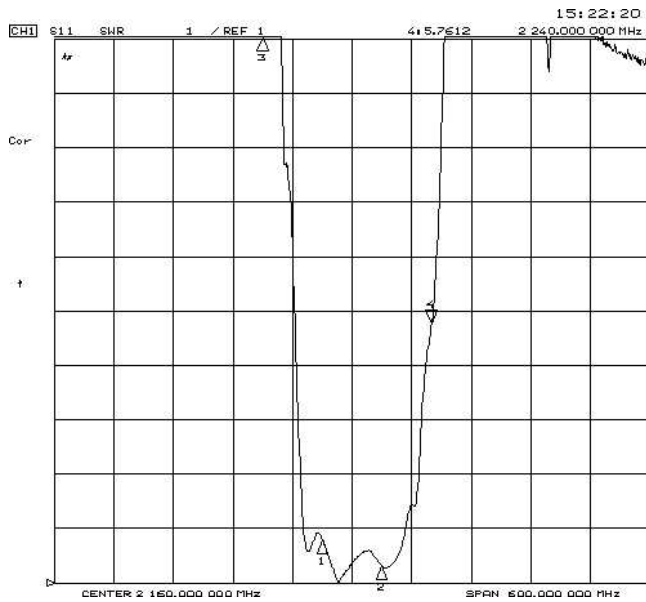

**S22**

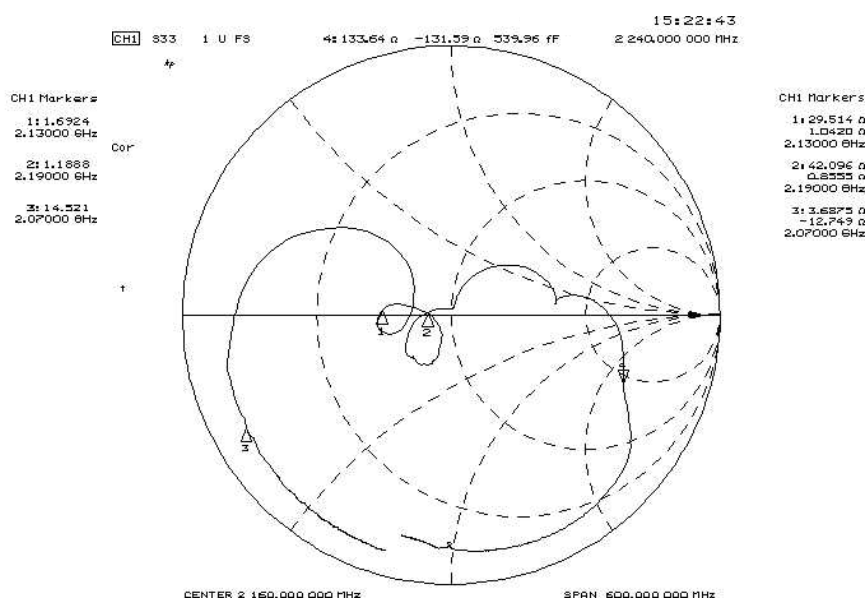
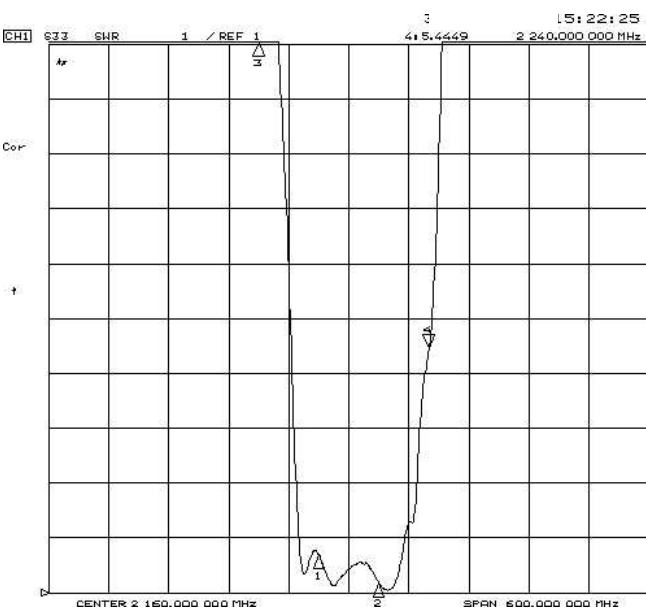

**2160.0MHz SAW Filter**

**Model: TA0465A**

**Part No: MA09944**

**REV NO.: 1**

**G. PACKING:**

**1. REEL DIMENSION**

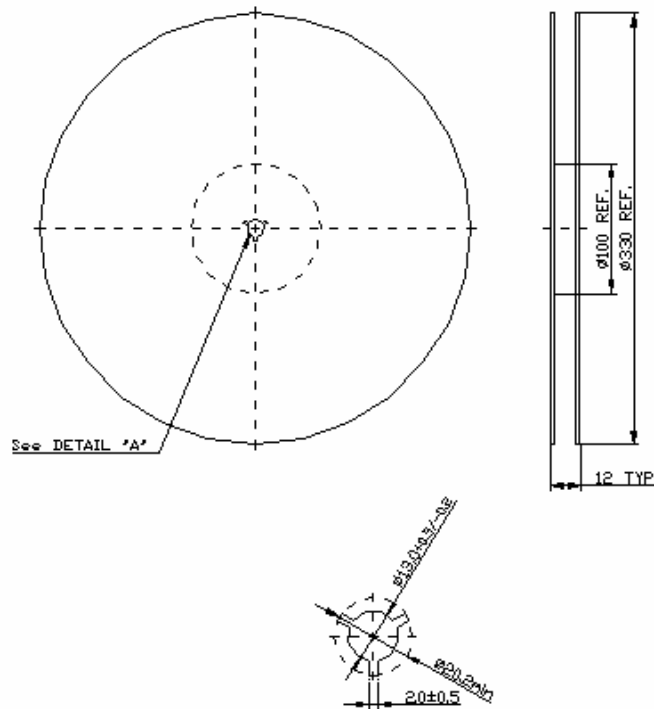

**2. TAPE DIMENSION**

