SAW Filter 1642.50MHz**Model: TA0426A****Part No: MA08088****REV. NO.: 1**

A. MAXIMUM RATING:

1. Input Power Level: 5 dBm
2. DC voltage: 5 V
3. Operating Temperature: -20°C to +75°C
4. Storage Temperature: -40°C to +85°C

B. ELECTRICAL CHARACTERISTICS:

Item	Min.	Typ.	Max.
Center frequency Fc (dB)	-	1642.5	-
Insertion loss within 1625 ~1660 MHz IL (dB)	-	2.1	3.5
Amplitude ripple (p-p) within 1625 ~ 1660 MHz (dB)	-	0.9	2.0
Attenuation (Reference level from 0 dB)			
DC ~ 1500 MHz (dB)	21	28	-
1525 ~ 1559 MHz (dB)	30	34	-
1700 ~ 2050 MHz (dB)	30	33	-
2050 ~ 3500 MHz (dB)	25	33	-
VSWR within 1625 ~1660 MHz	-	1.5	2.3
Source impedance Zs (Ω)	-	50	-
Load impedance ZL (Ω)	-	50	-

Note1. No matching network required for operation at 50Ω

SAW Filter 1642.50MHz

Model: TA0426A

Part No: MA08088

REV. NO.: 1

C. OUTLINE DRAWING:

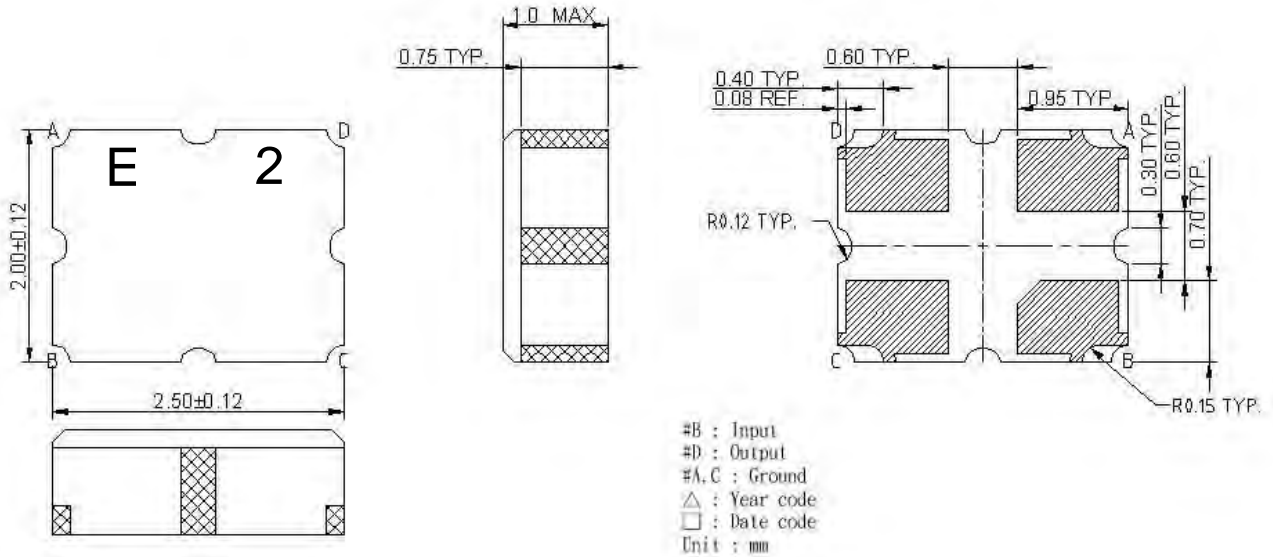

D. MEASUREMENT CIRCUIT:

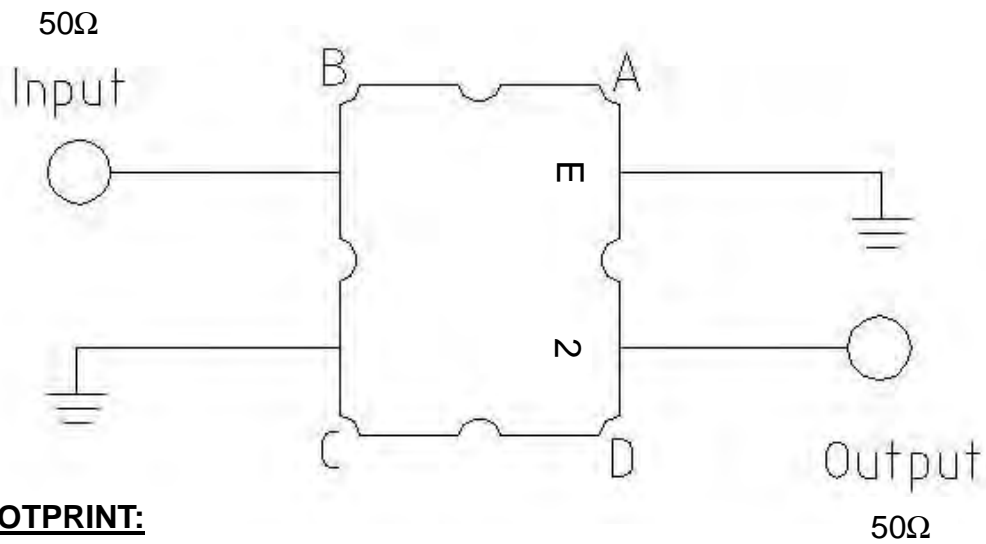

E. PCB FOOTPRINT:

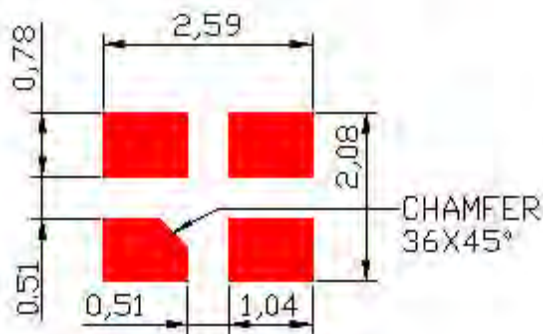

SAW Filter 1642.50MHz

Model: TA0426A

Part No: MA08088

REV. NO.: 1

F. FREQUENCY CHARACTERISTICS:

Transfer function

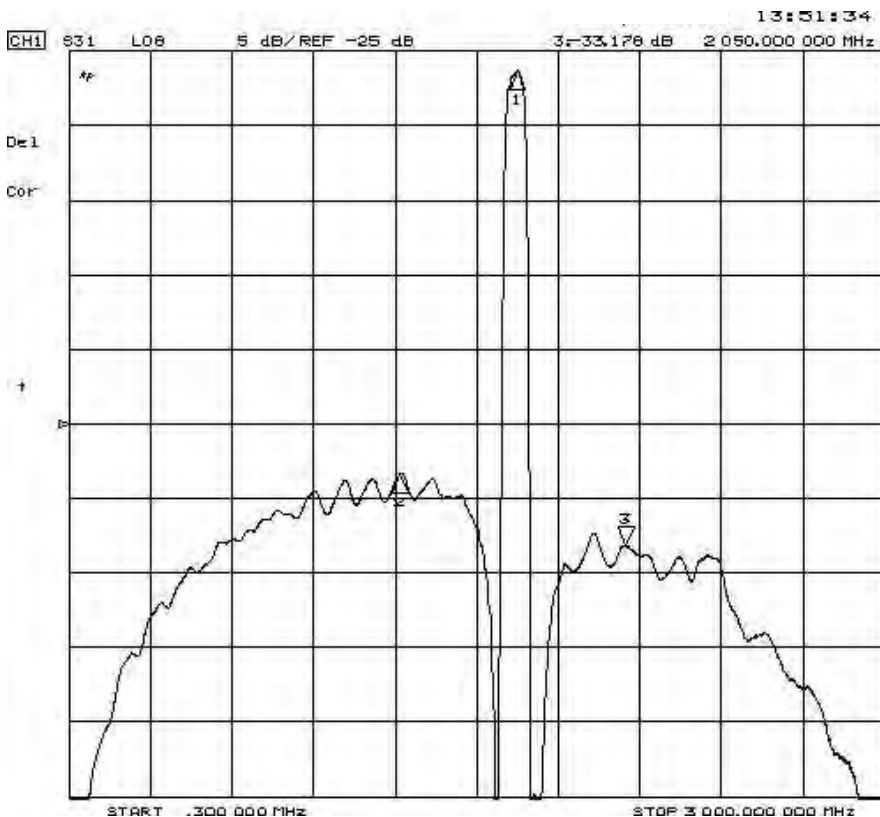
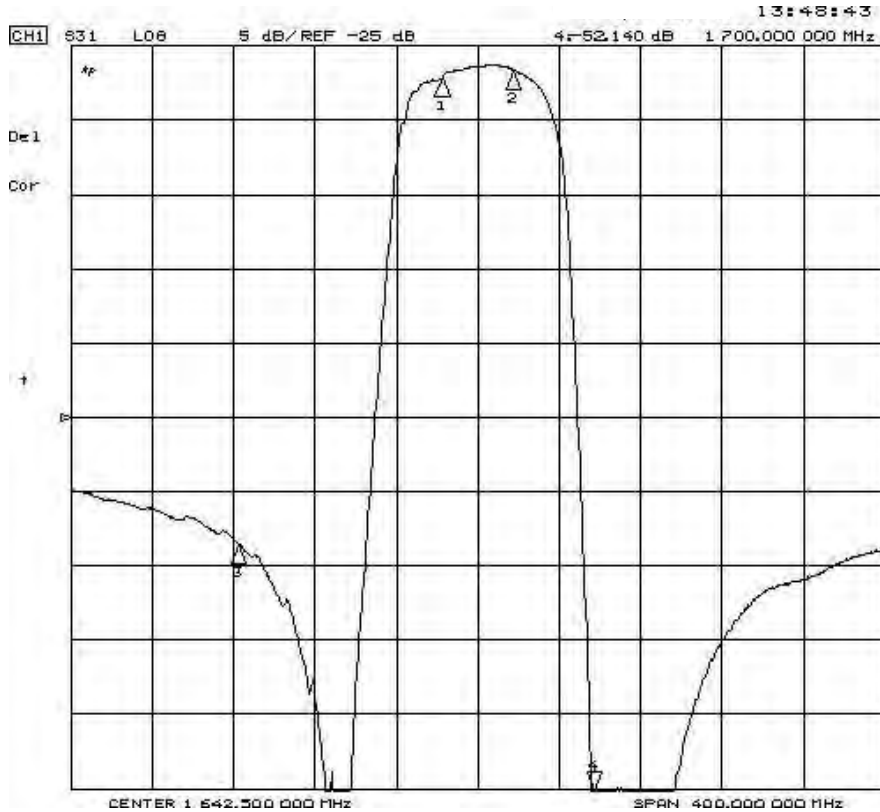

SAW Filter 1642.50MHz

Model: TA0426A

Part No: **MA08088**

REV. NO.: 1

Reflections Functions:

S11 VSWR

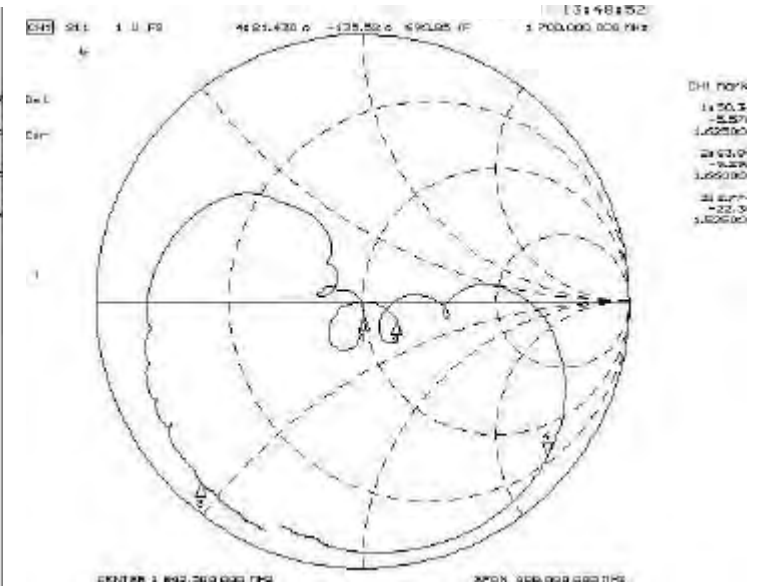
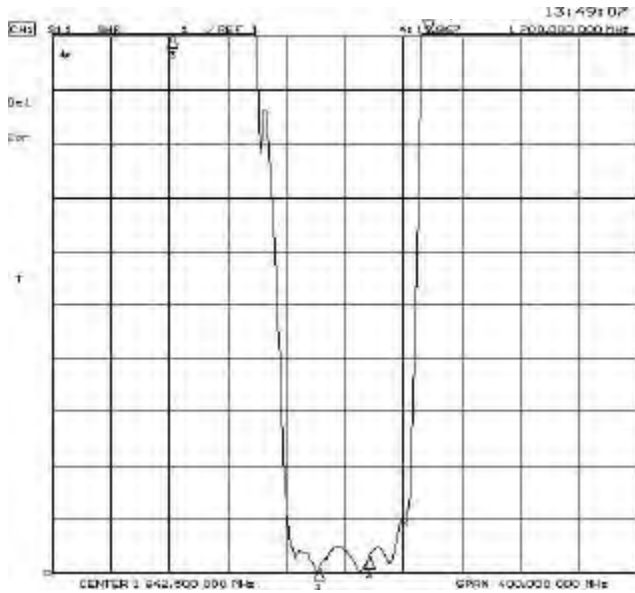

S22 VSWR

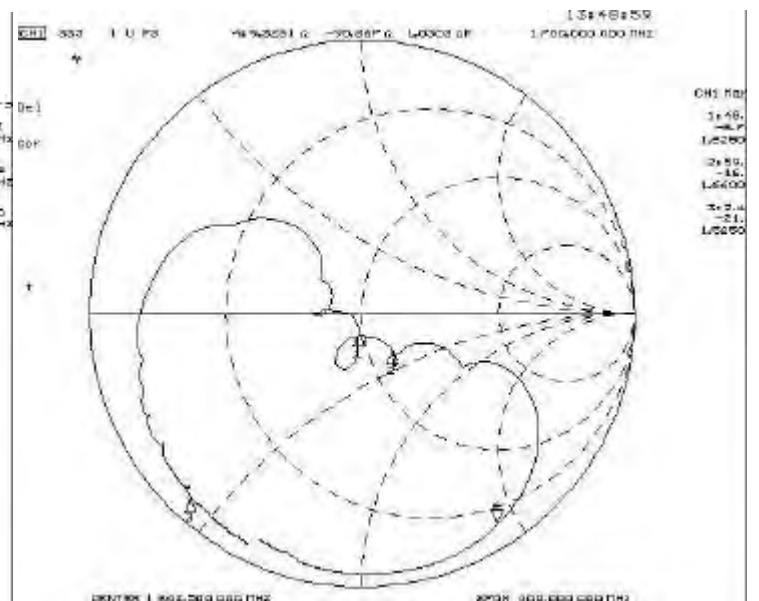
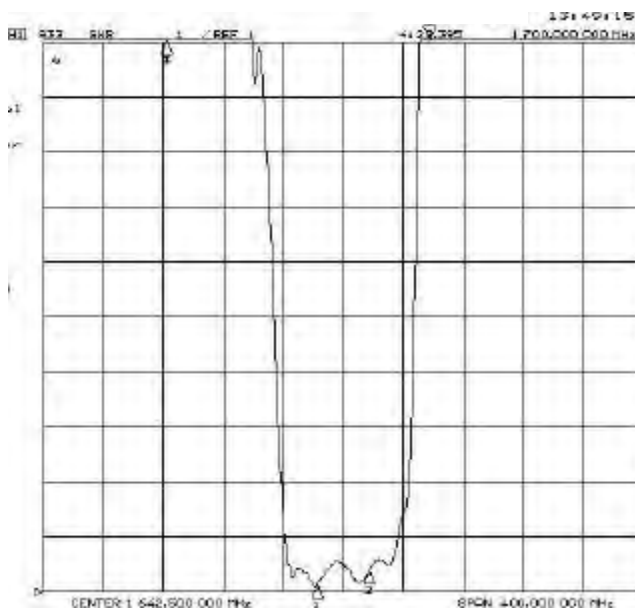

SAW Filter 1642.50MHz

Model: TA0426A

Part No: **MA08088**

REV. NO.: 1

G. PACKING:

1. REEL DIMENSION

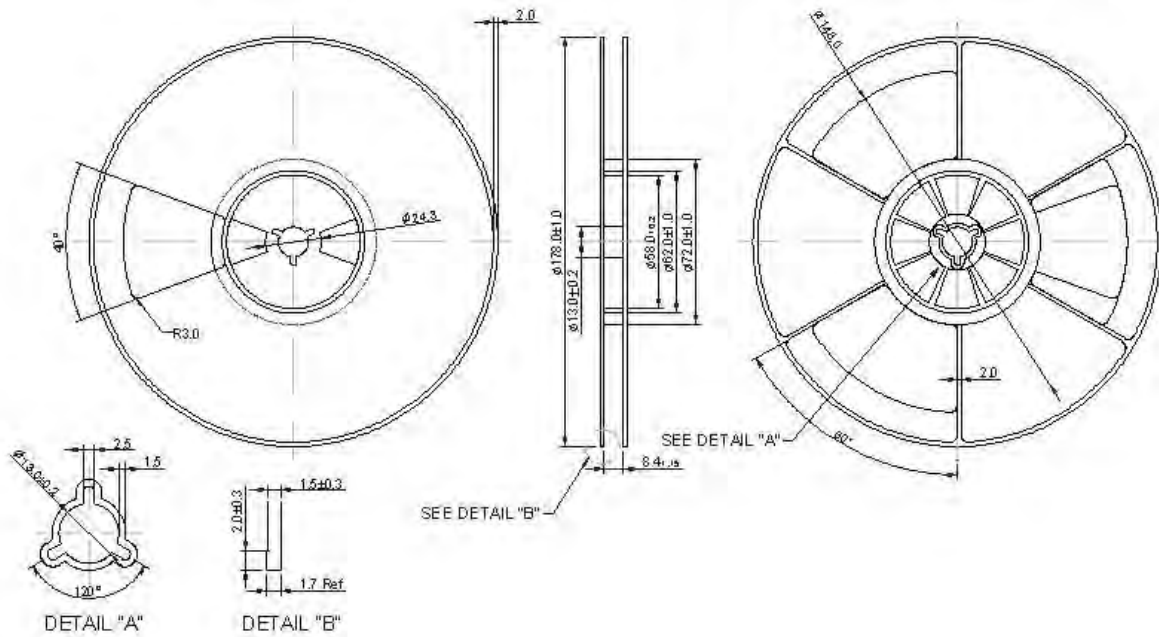

2. TAPE DIMENSION

