

## Product Description

Description:	24.5760MHz GXO-3306L/A SM Oscillator
Product family:	GXO-3306
Category:	SM Oscillator
Order code:	MP07787

## Features

- ▶ Ceramic package with metal lid
- ▶ Enable / disable tristate function

## Additional Information

For further information regarding packaging, construction, material composition, soldering profile and environment, please refer to **GXO-3306 Product Information sheet**

For dimensions, refer to package drawing: **D0354-A**

## Electrical Specifications

Parameter	Value	Notes
Nominal frequency:	24.5760MHz	
Frequency stability:	±25ppm max	Frequency stability is inclusive of calibration @25°C, operating temperature range, supply, voltage change, load change, shock and vibration.
Operating temperature range:	-40 to +85°C	
Storage temperature range:	-55 to +125°C	
Supply voltage (V <sub>DD</sub> ):	+3.3V	±10%
Supply current:	20mA max	
Driving ability:	15pF CMOS	
Logic levels:	'0' level = 10%V <sub>DD</sub> max '1' level = 90%V <sub>DD</sub> min	
Start up time:	5ms max	
Waveform symmetry:	45:55max	@50%V <sub>DD</sub>
Rise / fall time:	5ns max	
Phase jitter (RMS):	0.04ps typ	12.0kHz ~ 5.0MHz. For ultimate performance, a high frequency decoupling capacitor should be connected between supply and ground as close to the oscillator supply pad as possible. Low frequency decoupling should be placed next to supply source.
Phase noise (typ @24.576MHz):	-101dBc/Hz @10Hz -132dBc/Hz @100Hz -155dBc/Hz @1kHz -166dBc/Hz @10kHz -174dBc/Hz @100kHz -175dBc/Hz @1MHz -175dBc/Hz @5MHz	

## Enable / Disable Function

Input (pad 1)	Output (pad 3)
Open	Enabled
'1' level, >0.7V <sub>DD</sub>	Enabled
'0' level, <0.3V <sub>DD</sub>	High Impedance

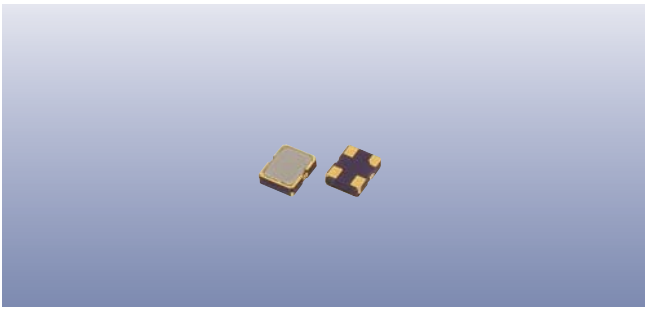

## Construction

- ▮ Ceramic body with gold-plated pads
- ▮ Metal lid, seam sealed

## Composition



This product is lead-free, and is fully compliant with current RoHS directives



## Packaging & Handling

Production quantities supplied on T&R, 2k pcs per reel.  
Small quantities may be supplied on tape (no reel), or in bulk.



♦ Static sensitive product. Observe proper handling precautions

## Marking

FREQUENCY  
DC

Marking type: Laser  
DC = Date code in YM, eg "CE" = May 2013

	A	B	C	D	E	F	G	H	J	K	L	M
Y	1	2	3	4	5	6	7	8	9	0		
M	Jan	Feb	Mar	Apr	May	Jun	Jul	Aug	Sep	Oct	Nov	Dec

## Tape & Reel Specification

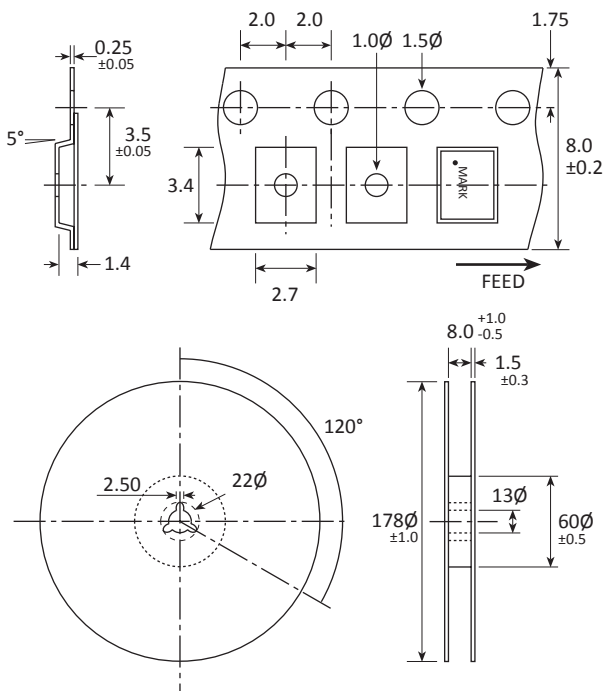

Not to scale. Dimensions in mm. Tolerances ±0.1mm unless otherwise stated.

## Soldering Profile

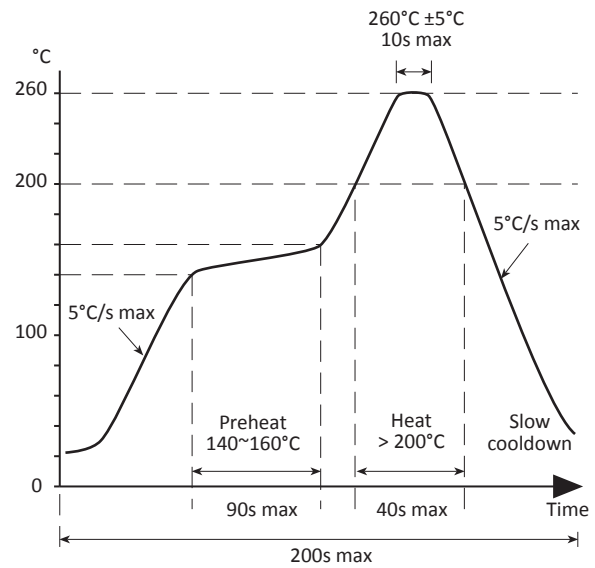

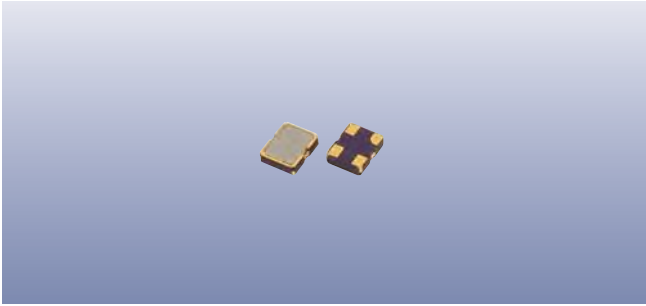

## Product Family

GXO-3300, GXO-3306, GXO-U119

## Construction

- ▮▮▮▮ Ceramic body with gold-plated pads
- ▮▮▮▮ Metal lid, seam sealed

## Dimensions (mm)

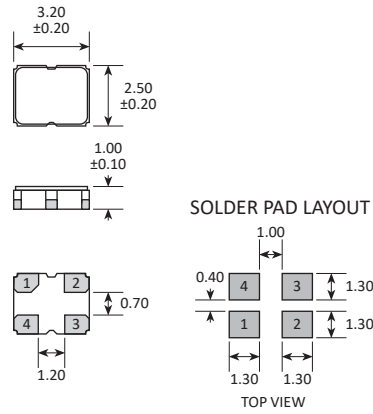

PAD	CONNECTION
1	Enable / disable
2	Ground
3	Output
4	Supply